



HoReCa
Papatya[®]
All comfort for you

Horeca Papatya





8

Kurumsal
Corporate

14

Proje Yönetimi
Project Management

16

İç kapı çözümleri
Interior door solutions

96

Performans uygulamaları
Interior doors project solutions

114

Butik uygulamalar
Special application

Kurumsal / Corporate

8

Monoblok Teknolojisi / Solid Monoblock® door technology

10

Kalite / Quality

12

Proje Yönetimi / Project Management

14

İÇ KAPI ÇÖZÜMLERİ / INTERIOR DOOR SOLUTIONS

16

Optima Plus

18

Divio

26

Divio Line

34

Maksima Plus

40

Kleon

48

Kleon Line

54

Fronia

60

Natura

66

Natura Royal

70

Organica

74

Organica Royal

78

Lamina

82

Glazio

86

Panora

90

İç Kapı Detayları / Interior door details

94

Standart Ölçüler / Standart dimensions

95

PERFORMANS UYGULAMALARI / PERFORMANCE APPLICATION

96

Yangın Dayanımlı Kapılar / Fire rated doors

98

X-Ray Korumalı Kapılar / X-ray protected doors

102

Ses Yalıtımlı Kapılar / Sound proof doors

103

Alüminyum Kasalı Kapılar / Doors with aluminum frames

104

Sac Kasalı Kapılar / Doors with steel frames

105

YANGIN KAPISI / FIRE DOOR

106

Metal Yangın Kapısı Teknik Özellikleri / Doors with steel frames

108

122 Açılım seçenekleri Door Opening Options



134 Ahşap daire giriş kapıları Wooden Flat Entrance Doors



140 İç kapı tamamlayıcı detaylar Interior Doors Complementary Details



146 Çelik kapı Steel Security Doors



166 Bütünleşik ahşap çözümleri Integrated Wood Solutions



BUTİK UYGULAMALAR / SPECIAL APPLICATION

114

Jaluzili Kapı / Jalousie doors

116

Deri Uygulama / Leather applications

117

Süpürgelik & Takoz Uygulamaları / Crown, architrave & batten applications

118

AÇILIM SEÇENEKLERİ / DOOR OPENING OPTIONS

122

Sabit Bölmeli Kapı Uygulamaları / Fixed transom and side panels applications

124

Çarpma Kapı / Double action swing doors

128

Katlanır Kapı / Folding doors

129

İçten Sürgülü Kapılar / In-wall sliding doors

130

Dıştan Sürgülü Kapılar / Out-wall sliding doors

132

AHŞAP DARE GİRİŞ KAPILARI / WOODEN FLAT ENTRANCE DOORS

134

Imperium Plus

136

İÇ KAPI TAMAMLAYICI DETAYLAR / INTERIOR DOORS COMPLEMENTARY DETAILS

140

Opsiyonel Aksesuarlar / Optional accessories

142

Master Anahtar Çözümleri / Master key solutions

144

ÇELİK KAPI / STEEL SECURITY DOORS

146

Sparta 8

148

Sparta 9

154

Wall Security

160

BÜTÜNLEŞİK AHŞAP ÇÖZÜMLERİ / INTEGRATED WOOD SOLUTIONS

166

Otel Proje Çözümleri / Hotel project solutions

168





||| Kurumsal

Türkiye'nin ilk kapı markası olarak yola çıkan Dortek, faaliyete başladığı günden bu yana Türkiye'de kapı mimarisi, tasarımı ve teknolojisine yön veren şirket olmuştur. Sürekli gelişen ürün gamı, anahtar teslim uygulama çözümü, montaj dahil garanti uygulaması, projelere özel mühendislik çözümleri, artan pazar payı ve yakaladığı başarı çizgisi ile Dortek, sektörünün lideri olma konumuna gelmiştir.

Kastamonu'da 30.000 m2 kapalı alanda üretimini sürdüren Dortek, yüksek üretim kapasitesi ve kalitesi ile Türkiye'nin, kapı üretiminde en büyük ve teknolojik anlamda en kapsamlı, üretim tesisi olma özelliğini taşımaktadır.

Fabrikasının makine parkında UV (Ultra Viole) Lake, Polimerik kaplama, Doğal ve Endüstriyel ahşap üretim hatları ile tam otomatik üretim yapmakta olan Dortek; konularında uzman ürün geliştirme, Ar-Ge ekibi, proje satış mühendisleri ve bayileri aracılığıyla yurt çapında konumlanan mağazaları ile, müşterilerine daha iyi bir hizmet vermeyi amaçlamaktadır. Dortek, performans uygulamaları, açılım seçenekleri ve ölçülerden bağımsız olarak ürün gamında yer alan 2000'den fazla iç kapı model seçeneği ile kapıda tartışmasız en geniş ürün yelpazesi ile hizmet vermektedir. Çelik kapı, yangın kapısı ve diğer performans kapılarına ek olarak; mutfak ve banyo uygulaması da bütünlüklü ahşap çözümlerinde öncelikli olarak yer almaktadır. Dortek, bir konutta ihtiyaç olan tüm ahşap bileşenleri, en uygun çözümlerle proje müşterilerine tek elden sunmaktadır. Bunun yanı sıra okul, hastane, ofis, AVM ve oteller için de tüm ahşap bileşenler aynı kalite ile sunulmaktadır.

Ürünlerinin kendisi için hiç bitmeyecek bir mimari uygulama alanı olduğunun bilincinde olan Dortek, daha yapılması gereken çok iş ve keşfedilmesi gereken yenilikler olduğunu düşünmektedir. İşini tutkuyla yapan ve ürün geliştirme çalışmalarına ciddi bir motivasyonla devam eden Dortek, geleceğe dair vizyonuyla, kapı ve mobilya dünyasının en iddialı çözüm ortaklarından birisi olmayı hedefliyor.

||| Corporate

As a pioneer door brand of Turkey, Dortek has been a leading company in door architecture, design and technology in Turkey since the day it started. Dortek has become the leader of the sector with its constantly developing product range, turnkey application solution, warranty application including installation, special engineering solutions for projects, increasing market share and success line.

Continuing the production of 30.000 m2 closed plant area in Kastamonu, Dortek is the largest and technologically most comprehensive production facility in Turkey with its high production capacity and quality.

Dortek manufactures fully automatic production with UV (Ultra Violet) Lacquer, Polymeric, Natural and Industrial wood production lines in the machinery park of the factory; Aims to provide superior service experience to its customers with product development specialist, R & D team, project sales engineers and branches locating all over the country through its dealers. Dortek offers wide range of products at the door, with more than 2000 internal door model options available in the products, regardless of performance applications, opening options and dimensions. In addition to steel doors, fire doors and other performance doors; kitchen and bathroom applications are also a priority in integrated wood solutions. Dortek offers all the wood components needed in a house with the most appropriate solutions to customers by a single source. Besides, all wooden components are offered with the same quality for schools, hospitals, offices, shopping malls and hotels.

Distinguishing its products are a never-ending architectural practice for Dortek it takes much work to be done and innovations that need to be explored. Dortek is committed to being one of the most ambitious solution partners of the door and furniture world with its vision of the future, making its business passionately and continuing its product development efforts with a genuine motivation.

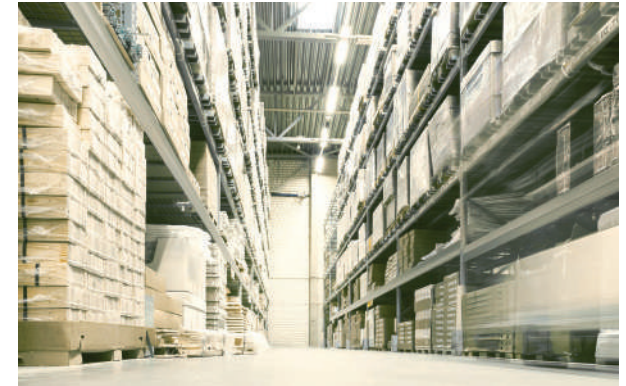



Monoblok® Teknolojisi

Bir Kapıda Olması Gereken En Temel Ayrıcalık Unsuru: Monoblok–dolü;

Türkiye'nin en profesyonel kapı çözümünün arkasında yatan teknoloji harikası ahşap levhanın adı. Ağaçlar, doğadaki ömrünü tamamladıktan sonra itinayla toplanıyor. Endüstriyel değerini yitirmiş olan ağaç kütleleri, orta yoğunluklu lif levha olarak şekillendiriliyor. Vida çekme mukavemetini maksimize etmesi için çok özel kimyasal bileşenlerle bir araya gelen lif levha, 540 kg/m³ ile 850 kg/m³ arasında değişen yoğunluklarda ve farklı kalınlıklarda üretiliyor. Ürün platformlarının her birinde, yüzey teknolojilerinin gereksimine göre farklı yoğunlukta levhalar kullanılıyor.

Buna ek olarak, kapıyı oluşturan 3 bileşenli yapının her bir bileşeni için de ürünün mekanik gereksinimlerine göre lif levhanın farklı yoğunluklardaki versiyonları tercih ediliyor. Kasada, kanatta ve pervazda da yoğunluk farklılıkları oluyor. Lif levha içine enjekte edilen çevre dostu reçine ve diğer kimyasal bileşen karışımı, kullanım gereksinimine göre, optimize ediliyor. Ortaya çıkan farklı yoğunlukta plakalar kapı bileşimlerinde bir araya geliyor ve uzun ömürlü kullanım için mükemmel bir harmoni oluşturuyor.

Tek parça halinde üretim anlamına gelen monoblok-dolu teknoloji sayesinde; istenen herhangi bir desen, logo, hatta bir insan yüzünün şekli bile monoblok kapı kanadına, 3 boyutlu konkav/konveks bir rölyef olarak işlenebiliyor. Tasarım ve işlevsellikte sınırları ortadan kaldıran bu teknoloji ile gerektiğinde 70mm'ye ulaşan tek parça halinde kapı üretimi gerçekleştiriliyor. Bu sayede darbelere dayanıklı, ısı ve ses yalıtımı yüksek, isteğe bağlı olarak yangına ve suya dayanıklı, geri dönüşümlü malzemeden, çevre dostu kapı üretimi yapılıyor.

Monoblock® Technology

Essential Requirement at a Door: Solid Monoblock;

Turkey's most professional door solution behind the technology wonder of the name of the wooden plate. The trees gathered with care after they have completed the life in the nature. The tree masses, which lost their industrial value, are shaped as medium density fiberboard. The fiber sheet, which combines very special chemical components to maximize the screwing strength, is produced in different thicknesses with density ranging from 540 kg / m³ to 850 kg / m³. In each of the product platforms, different density plates are used depending on the needs of the surface technologies.

The 3-component structure that forms the door, different versions of the fiber sheet are preferred depending on the mechanical requirements of the product. There are also density differences in the frame, architrave and leaf. The mixture of environmentally friendly resin and other chemical components injected into the fiberboard is optimized according to the usage requirement. The resulting plates of different densities come together in door combinations and create a perfect harmony for long-lasting usage.

Benefit of solid monoblock technology, which means production in one piece; Any desired pattern, logo, even the shape of a human face can be processed as a three-dimensional concave / convex relief on the monoblock door leaf. With this technology, which removes the limits from the design and functionality in the middle, it is possible to produce one piece of door which reaches 70mm if necessary. In this respect, production of environmentally friendly door is made from the recycled material resistant to shrinkage, high heat and sound insulation, If desired, it can be resistant to fire and water as well.

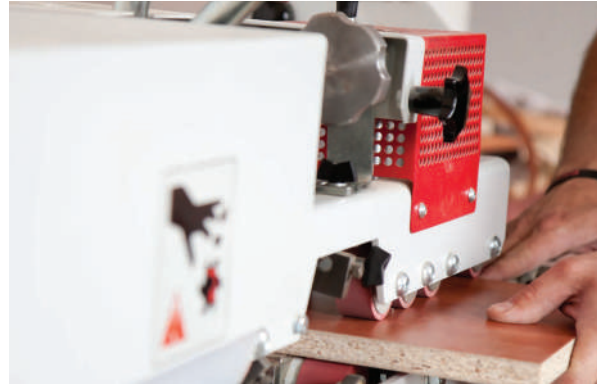



||| Kalite

En temel değerlerimizden biri de müşterilerimize taahhüt ediyor olduğumuz yüksek kalite standartlarıdır.

Dortek ürünlerinde kullanılan tüm bileşenler, yılların ortaya koyduğu deneyimle, titizlikle seçilir. Kullanılan ahşap lif levha, astar, boya, kaplamalar, aksesuarlar ve diğer bileşenler, Dortek kalite çizgisine paralel olacak şekilde Avrupa Birliği normlarına uygun, sertifikasyonları tamamlanmış tedarikçilerden temin edilir ve DIN normlarında olmasına özellikle dikkat edilir.

Ürün geliştirme çalışmalarında, üretilen her yeni ürün, yaşlandırma deneylerine tabi tutulur. Hizmete sunulmadan önce kalite kontrol süreçleri özenle takip edilir.

Keşif, ölçü, demontaj ve montaj hizmetlerini satışın ayrılmaz bütünlüğü içerisinde tamamlayan Dortek'in en önemli ilkesi, müşteri memnuniyetini üst düzeyde sağlamaktır.

Kaliteye olan tutkumuzla, sizlere bir üründen çok daha fazlasını sunuyoruz. Korumak, konfor sağlamak, bir tarzı ifade etmek ve değer yaratmak için tasarlanmış ürün ve hizmetler Bunlar bizden bekleyebileceğinizdir.

||| Quality

One of our most fundamental values is the high quality standards that we are committed to our customers.

All components used in Dortek products are meticulously selected with years of experience. The wood fiber board, lining, paint, coatings, accessories and other components used are supplied from certified suppliers compliant with European Union norms in line with the Dortek quality line and pay particular attention to being in DIN norms.

In product development studies, every new product produced is subjected to aging tests. Quality control processes are followed carefully before being submitted to the service.

The most important principle of Dortek, which completes discovery, measurement, disassembly and assembly services within the integral part of sale, is to provide customer satisfaction at a high level.

With our passion for quality, we offer you far more than a product. Products designed to protect, provide comfort, express style and create value services. These are the things you can expect from us.

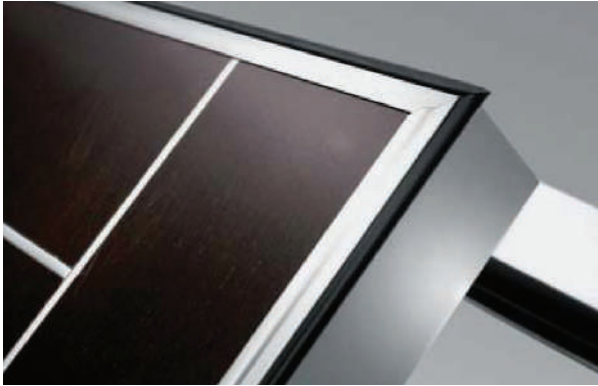

||| Proje Yönetimi

Dortek, mimari projelere sunduğu ürün ve çözümlerinin yanı sıra; mimar, iç mimar, dekoratör, mühendis ve yüklenici/yatırımcı firmalara verdiği proje danışmanlık desteği ile de iddialı bir hizmet politikası sürdürüyor.

Alanında uzman satış, ürün geliştirme ve ürün yönetimi ekiplerince, tüm projeler titizlikle inceleniyor. Mimari gereksinimlere ve projelerin tasarım ve işlevsel beklentilerine cevap olabilecek çözüm önerileri özenle hazırlanıyor. Dortek proje danışmanları, proje şartnamesine uygun ürün tekliflerini hazırlarken aynı zamanda gerekli teknik desteği de kurumsal müşterilerine kapsamlı bir şekilde sunuyor.

Dortek yılların ortaya koyduğu deneyim ve bilgi birikimini, kapı ve bütünlük ahşap çözümlerinin gereksinim duyulduğu hemen her projede, profesyonelce ortaya koyuyor. Doğru ürün, doğru fiyat, zamanında teslimat ve uygulama dahil garanti çözümü; hizmet paketi içerisinde titizlikle ele alıyor.

Dortek, alışveriş merkezi projeleri, hastaneler, iş merkezleri, otel projeleri, endüstriyel tesisler, toplu konut projeleri vb. projeler için gereken kapı, mutfak ve diğer ahşap çözümlerini; dünyadaki yenilikleri takip ederek kurumsal müşterilerine hızlı ve verimli bir şekilde sunuyor.



||| Project Management

Dortek, besides the products and solutions offered by architectural projects, architect, interior designer, project consultant, engineer, contractor, and investor firm which also maintains an ambitious service policy with support. In the field of expert sales, product development and product management teams, all projects being meticulously examined.

Architectural needs and projects are designed according to provide functional solutions to meet client expectations is carefully prepared. Dortek project consultants provide product proposals for the project specifications, which is crucial to technical support to its residential and commercial clients to examine in an extensive way.

Dortek over the course of years gained significant experience and knowledge, it reveals integrated doors in almost every project where wood solutions are needed by determining right product, right price, on-time delivery and application warranty solution; which is presented in the service package to clients.

Dortek besides residential projects, which also provides wood solutions to shopping center projects, hospitals, business centers, hotel projects, industrial facilities, and mass housing projects by required doors for the projects, kitchen and other wood solutions; to corporate clients by following the innovations in the world promptly and efficiently.



İç Kapı Çözümleri / Interior Door Solutions

Optima Plus

Divio

Divio Line

Maksima Plus

Kleon

Kleon Line

Fronia

Natura

Natura Royal

Organica

Organica Royal

Panora

Glazio

Lamina

Optima Plus

Optima Plus polimerik kaplamalı modelleri ve renk alternatifleri ile hayal dünyanızda yeni kapılar açıyor.

Optima Plus opens up new doors in your world with its polymeric veneered models and color alternatives.













Performans Uygulamaları Performance Applications

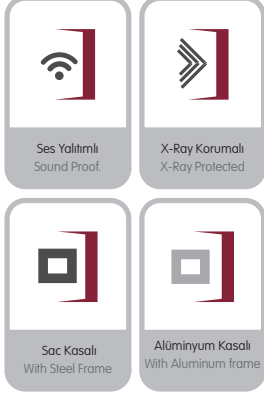

Donanım Özellikleri Hardware Features



Kullanım Alanları Area of use

Otel / Hotel

Imperium Plus Daire Giriş Kapısı
Imperium Plus Flat Entrance Door

Sparta 8 & Sparta 9 Çelik Kapı Giydirme Uygulaması
Sparta 8 & Sparta 9 Steel Door Wood Panel Applications

Öneriler Suggestions

*Optima Plus serisi kapıların, dış hava koşullarına direkt olarak maruz kalınan noktalarda kullanılması kesinlikle önerilmemektedir. Sundurma, rüzgarlık, gölgelik ve benzeri yarı korumalı sistemlerden sonra giriş kapısı olarak kullanılabilir.

It is not recommended to use Optima Plus series doors in places exposed directly to weather condition. Can only be used, if door location is protected from weather conditions by porch, shade etc.



PO 013
Milano Ceviz / Milano Walnut

Renk Seçenekleri Color Alternatives



*Beyaz ve Fildişi renkleri sadece 005, 006, 192, 104 G, 103 G5, 5F1, 5F2, 5F3, 7F2 modellerinde uygulanmaktadır.

White and Ivory colors are only available on doors with 005, 006, 192, 104 G, 103 G5, 5F1, 5F2, 5F3, 7F2 styles.

Donanım Renk Seçenekleri Hardware Color Alternatives



Uygulanabilir Modeller Styles

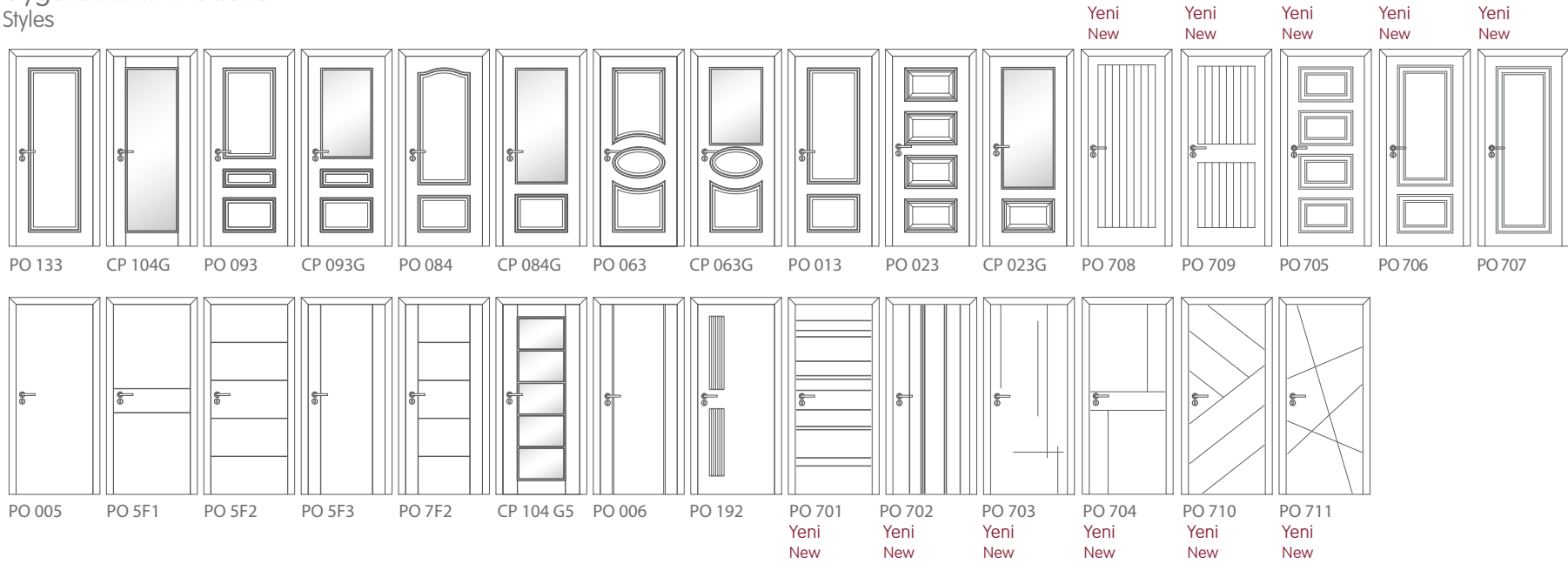

Profil Detayı Profile Details

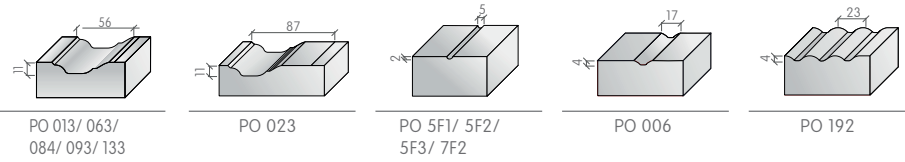

Standart Donanım Standard Hardware

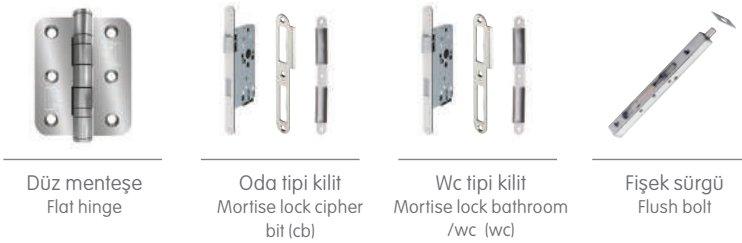

Opsiyonel Donanım Optional Hardware



Kasa - Pervaz Seçenekleri Frame - Architrave Options

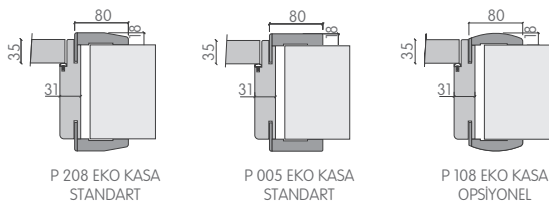

Cam Uygulama Detayı Glazing Details

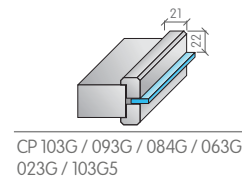

Divio

Divio polimerik kaplama ile ahşabın klasik çizgilerini buluşturuyor.

Divio combines polymeric coating with classical lines of wood.













Performans Uygulamaları Performance Applications

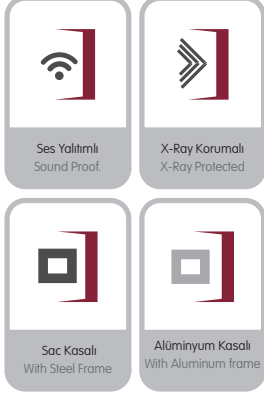

Kullanım Alanları Area of use

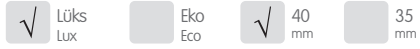

Kullanım Seçenekleri Area of use

Otel / Hotel
Imperium Plus Daire Giriş Kapısı
Imperium Plus Flat Entrance Door

Sparta 8 & Sparta 9 Çelik Kapı Giydirme Uygulaması
Sparta 8 & Sparta 9 Steel Door Wood Panel Applications

Öneriler Suggestions

*Divio serisi kapıların, dış hava koşullarına direkt olarak maruz kalınan noktalarda kullanılması kesinlikle önerilmemektedir. Sundurma, rüzgarlık, gölgelik ve benzeri yarı korumalı sistemlerden sonra giriş kapısı olarak kullanılabilir.

It is not recommended to use Divio series doors in places exposed directly to weather condition. Can only be used, if door location is protected from weather conditions by porch, shade etc.



DV 151
Koyu Ceviz / Dark Walnut

Renk Seçenekleri Color Alternatives



Donanım Renk Seçenekleri Hardware Color Alternatives



Uygulanabilir Modeller Styles

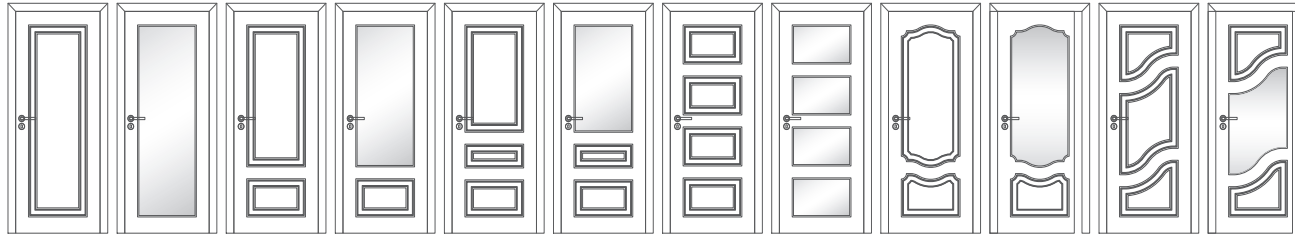

DV 131 CD 131G DV 011 CD 011G DV 091 CD 091G DV 021 CD 021G4 DV 051 CD 051G DV 071 CD 071G

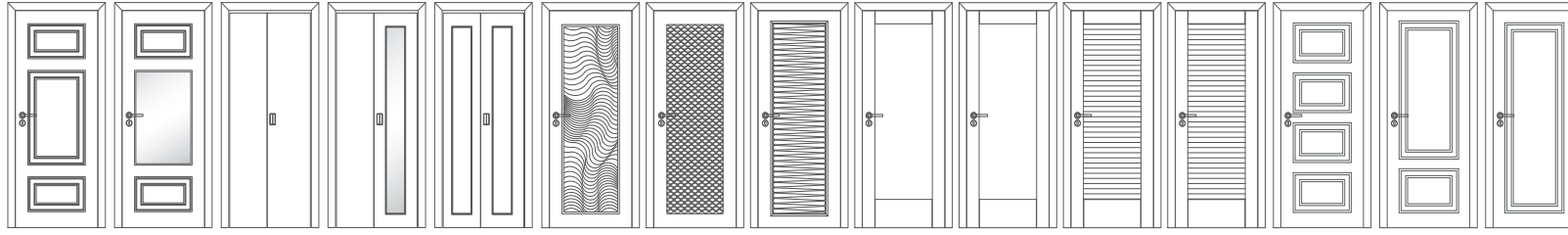

DV 151 CD 151G DV K05 CD K05C1 DV K05C2 DV 510 DV 520 DV 530 DV 540 (TEK RENK) DV 541 (ÇİFT RENK) DV 550 (TEK RENK) DV 551 (ÇİFT RENK) DV 705 DV 706 DV 707
Yeni New Yeni New Yeni New

Profil Detayı Door Profile Details

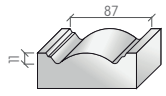

DV 011/ 021/ 051/ 071/
091/ 131/ 151

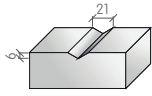

DV 510/ 520/ 530

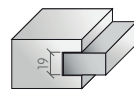

DV 540/ 541



DV 550/ 551

Standart Donanım Standard Hardware



Düz menteşe
Flat hinge



Oda tipi kilit
Mortise lock cipher
bit (cb)



Wc tipi kilit
Mortise lock bathroom
/wc (wc)



Fişek sürgü
Flush bolt

Opsiyonel Donanım Optional Hardware



Barelli kilit
Mortise lock profilo
cylinder (pc)



Gizli menteşe
Concealed hinge
*45 mm'lik kasada kullanılır.



Stoper
Door buffer



Pivot Menteşe
Pivot hinge

Kasa - Pervaz seçenekleri Frame - Architrave options

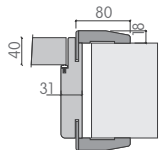

P 208 DÜZ KASA
STANDART

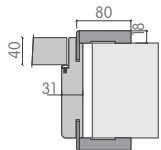

P 005 DÜZ KASA
STANDART

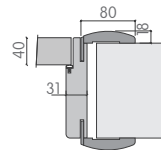

P 108 DÜZ KASA
OPSİYONEL

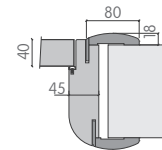

P 108 / 107 BOMBE DÜZ KASA
OPSİYONEL

Cam Uygulama Detayı Glazing Details

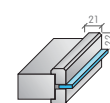

CD G/CD G5/CD G10

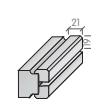

CD G75

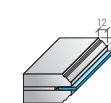

CD 011G/CD 021G/CD 051G/
CD 071G/CD 091/CD 131G/CD 151G

Divio Line

Divio Line modern ve dokunulalı bir yüzey oluşturan polimerik soft-touch katmanı ile kapiya ayrıcalık katıyor.

Divio Line provides privilege to doors with its polymeric soft-touch layer that creates a modern and tactual surface.









Performans Uygulamaları Performance Applications

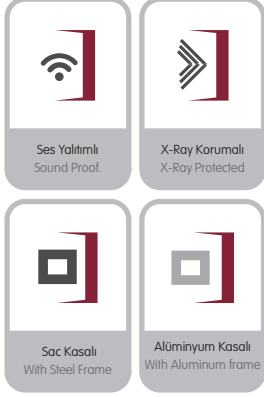

Donanım Özellikleri Hardware Features

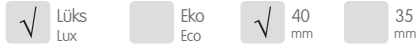

Kullanım Alanları Area of use

Otel / Hotel
Imperium Plus Daire Giriş Kapısı
Imperium Plus Flat Entrance Door

Sparta 8 & Sparta 9 Çelik Kapı Giydirme Uygulaması
Sparta 8 & Sparta 9 Steel Door Wood Panel Applications

Öneriler Suggestions

*Divio Line serisi kapıların, dış hava koşullarına direkt olarak maruz kalınan noktalarda kullanılması kesinlikle önerilmemektedir. Sundurma, rüzgarlık, gölgelik ve benzeri yarı korumalı sistemlerden sonra giriş kapısı olarak kullanılabilir.

It is not recommended to use Divio Line series doors in places exposed directly to weather condition. Can only be used, if door location is protected from weather conditions by porch, shade etc.



CD G75
Koyu Ceviz / Dark Walnut

Renk Seçenekleri Color Alternatives



Donanım Renk Seçenekleri Hardware Color Alternatives



Uygulanabilir Modeller Styles



DV 005 DV 5F1 DV 5F2 DV 5F3 CD G CD G5 CD G10 CD G75 DV J01

Profil Detayı Door Profile Details

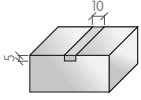

DV 5F1/ 5F2/ 5F3
*Alüminyum Fugali

Standart Donanım Standard Hardware



Düz menteşe
Flat hinge



Oda tipi kilit
Mortise lock ciphher
bit (cb)



Wc tipi kilit
Mortise lock bathroom
/wc (wc)



Fişek sürgü
Flush bolt

Opsiyonel Donanım Optional Hardware



Barelli kilit
Mortise lock profilo
cylinder (pc)



Gizli menteşe
Concealed hinge
*45 mm'lik kasada kullanılır.



Stoper
Door buffer



Pivot Menteşe
Pivot hinge

Kasa - Pervaz seçenekleri Frame - Architrave options

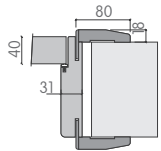

P 208 DÜZ KASA
STANDART

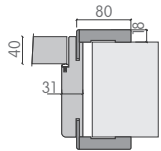

P 005 DÜZ KASA
STANDART

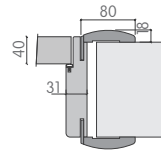

P 108 DÜZ KASA
OPSİYONEL

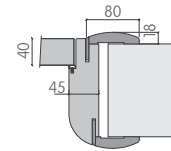

P 108 / 107 BOMBE DÜZ KASA
OPSİYONEL

Cam Uygulama Detayı Glazing Details

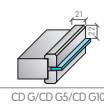

CD G/CD G5/CD G10

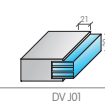

DV J01

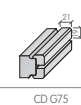

CD G75

Maksima Plus

Maksima Plus en son teknoloji kullanarak ahşabın doğallığı ve lakenin asaletini birleştiriyor.

Maksima Plus combines the noble nature of wood and the loyalty of the lacquer by using state-of-the-art technology.





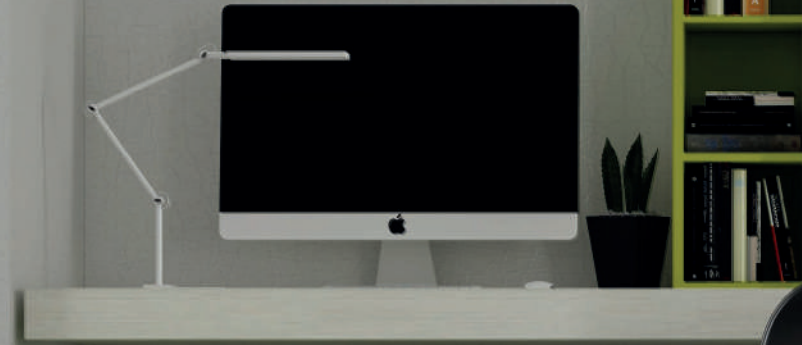







Maksima Plus

Performans Uygulamaları Performance Applications



Donanım Özellikleri Hardware Features



Kullanım Alanları Area of use

Otel / Hotel

Imperium Plus Daire Giriş Kapısı
Imperium Plus Flat Entrance Door

Sparta 8 & Sparta 9 Çelik Kapı Giydirme Uygulaması
Sparta 8 & Sparta 9 Steel Door Wood Panel Applications

Öneriler Suggestions

*Maksima Plus serisi kapıların, dış hava koşullarına direkt olarak maruz kalınan noktalarda kullanılması kesinlikle önerilmemektedir. Sundurma, rüzgarlık, gölgelik ve benzeri yarı korumalı sistemlerden sonra giriş kapısı olarak kullanılabilir.

It is not recommended to use Maksima Plus series doors in places exposed directly to weather condition. Can only be used, if door location is protected from weather conditions by porch, shade etc.



CS I04 G5
7044 Gri / 7044 Gray

Renk Seçenekleri Color Alternatives



*Maksima Plus ürün grubunda UV lake boya ve tüm yardımcı ürünlerde



kullanılmaktadır.

Donanım Renk Seçenekleri Hardware Color Alternatives



Uygulanabilir Modeller Styles

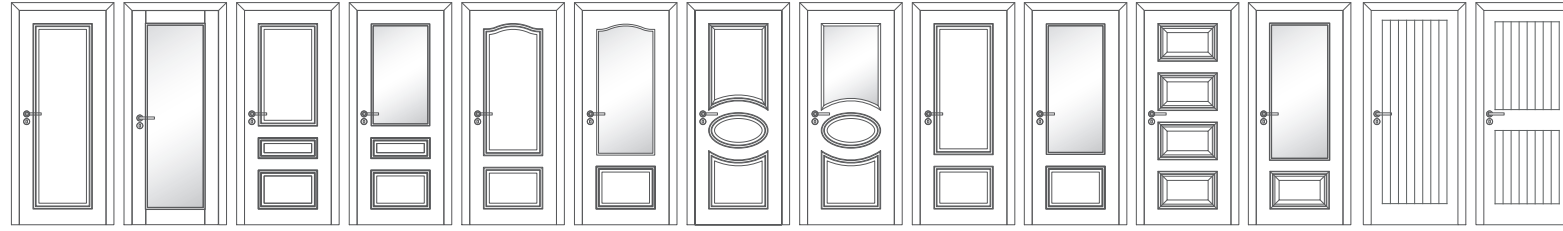

MP 133 CP 104G MP 093 CS 093G MP 084 CS 084G MP 063 CS 063G MP 013 CS 013G MP 023 CS 023G MP 708 MP 709

Yeni
New

Yeni
New

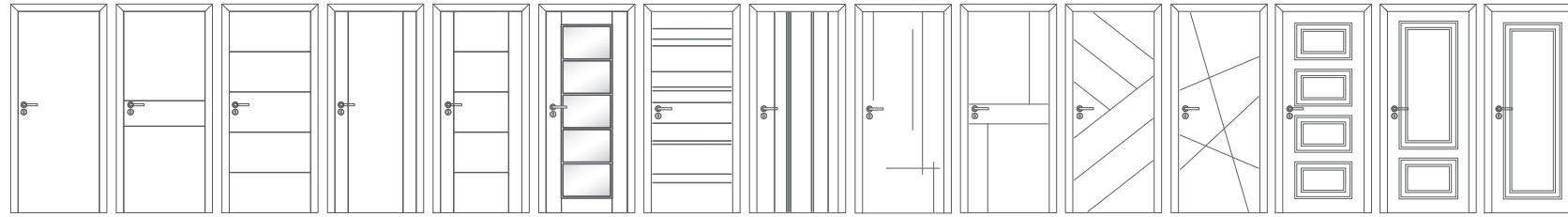

MP 005 MP 5F1 MP 5F2 MP 5F3 MP 7F2 CP 104 G5 MP 701 MP 702 MP 703 MP 704 MP 710 MP 711 MP 705 MP 706 MP 707

Yeni
New

Yeni
New

Yeni
New

Yeni
New

Yeni
New

Yeni
New

Yeni
New

Yeni
New

Yeni
New

Profil Detayı Door Profile Details

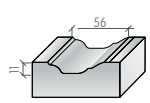

MP 013/ 063/
084/ 093/ 133

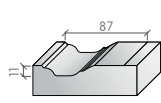

MP 023

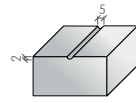

MP 5F1/ 5F2/
5F3/ 7F2

Standart Donanım Standard Hardware



Düz menteşe
Flat hinge



Oda tipi kilit
Mortise lock cipher
bit (cb)



Wc tipi kilit
Mortise lock bathroom
/wc (wc)



Fişek sürgü
Flush bolt

Opsiyonel Donanım Optional Hardware



Barelli kilit
Mortise lock profilo
cylinder (pc)



Giyotin süpürgelik
Door bottom mobile
sill



Stoper
Door buffer



Hidrolik kapatıcı
Door closer

Kasa - Pervaz seçenekleri Frame - Architrave options

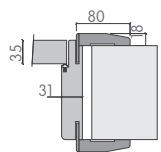

P 208 EKO KASA
STANDART

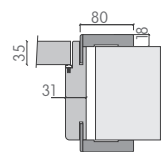

P 005 EKO KASA
STANDART

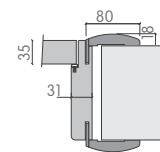

P 108 EKO KASA
OPSIYONEL

Cam Uygulama Detayı Glazing Details

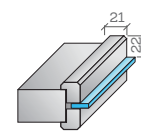

CS 103G / 093G / 084G / 063G
013G / 023G / 103G5

Kleon

Kleon UV lakenin ahşap ile mükemmel uyumunu klasik çizgilerle yeniden yorumluyor.

Kleon reinterprets the perfect harmony of UV laquer with classical lines.









Performans Uygulamaları Performance Applications

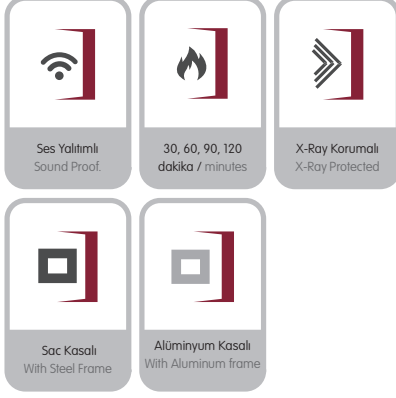

Donanım Özellikleri Hardware Features



Kullanım Alanları Area of use

Otel / Hotel

Imperium Plus Daire Giriş Kapısı
Imperium Plus Flat Entrance Door

Sparta 8 & Sparta 9 Çelik Kapı Giydirme Uygulaması
Sparta 8 & Sparta 9 Steel Door Wood Panel Applications

Öneriler Suggestions

*Kleon serisi kapıların, dış hava koşullarına direkt olarak maruz kalınan noktalarda kullanılması kesinlikle önerilmemektedir. Sundurma, rüzgarlık, gölgelik ve benzeri yarı korumalı sistemlerden sonra giriş kapısı olarak kullanılabilir.

It is not recommended to use Kleon series doors in places exposed directly to weather condition. Can only be used, if door location is protected from weather conditions by porch, shade etc.



KL 132
Fildişi / Ivory

Renk Seçenekleri Color Alternatives

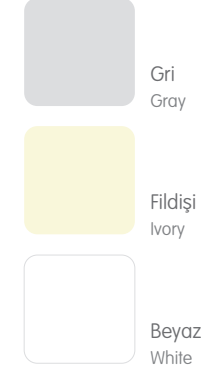

*Kleon ürün grubunda UV lake boya ve tüm yardımcı ürünlerde



kullanılmaktadır.

Donanım Renk Seçenekleri Hardware Color Alternatives



Uygulanabilir Modeller Styles

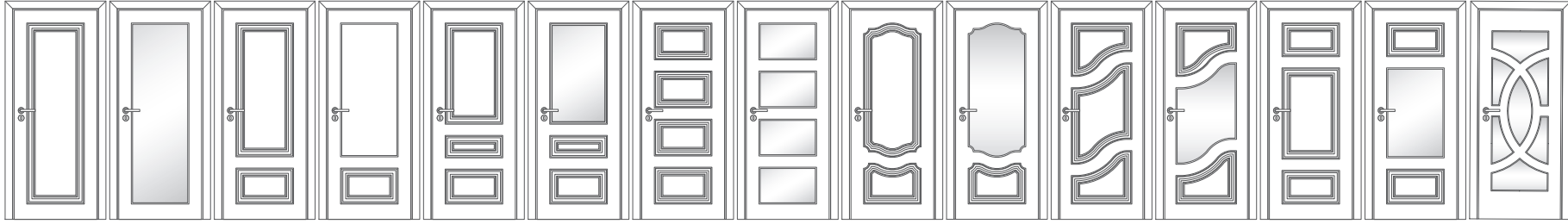

KL 132 CK 132G KL 012 CK 012G KL 092 CK 092G KL 022 CK 022G4 KL 052 CK 052G KL 072 CK 072G KL 152 CK 152G CK 600G

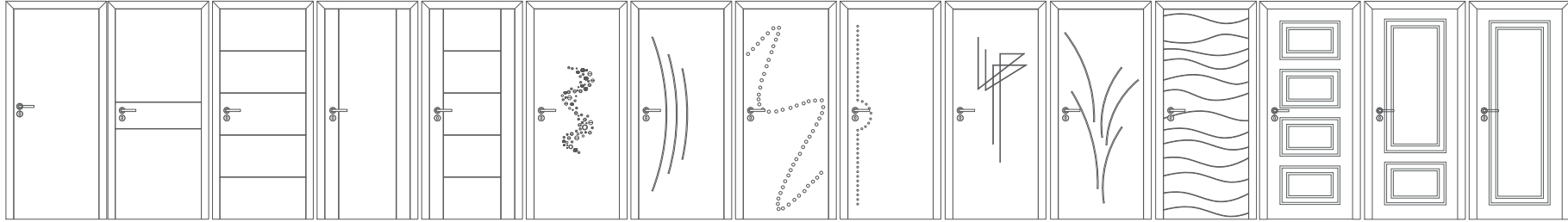

KL 005 KL 5F1 KL 5F2 KL 5F3 KL 7F2 KW 601 KW 602 KW 603 KW 604 KW 608 KW 611 KW 612 KL 705 Yeni New KL 706 Yeni New KL 707 Yeni New

Profil Detayı Door Profile Details

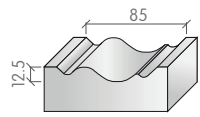

KL 012/ 022/ 052/
072/ 092/ 132/ 152

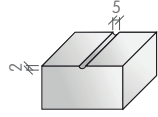

KL 5F1/ 5F2/ 5F3/ 7F2

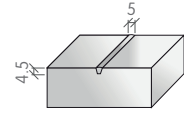

TAŞLI MODEL

Standart Donanım Standard Hardware



Saplama menteşe
Drill-in hinge



Oda tipi kilit
Mortise lock cipher
bit (cb)



Wc tipi kilit
Mortise lock bathroom
/wc (wc)



Fişek sürgü
Flush bolt

Opsiyonel Donanım Optional Hardware



Yaprak menteşe
Butt hinge



Pivot Menteşe
Pivot hinge



Stoper
Door buffer



Barelli kilit
Mortise lock profilo
cylinder (pc)

Kasa - Pervaz seçenekleri Frame - Architrave options

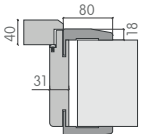

P 208 BİNİLİ KASA
STANDART

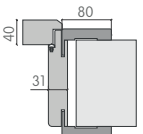

P 005 BİNİLİ KASA
STANDART

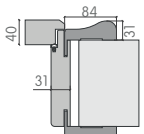

P 608 BİNİLİ KASA
STANDART

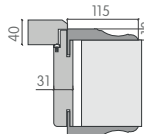

P 908 BİNİLİ KASA
OPSİYONEL

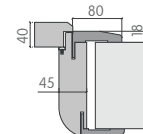

P 208, P107 BİNİLİ KASA
OPSİYONEL

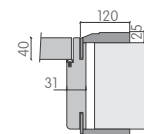

P 808 EKO KASA
OPSİYONEL

*Kristal uygulamalı kapılar düz kanatlı (binisiz) üretilir.

Cam Uygulama Detayı Glazing Details

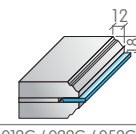

CK 012G / 022G / 052G / 072G
092G / 132G / 152G / 600G

Kleon Line

Kleon Line pürüzsüz lake yüzeyi ve yüksek kaliteli detay çözümleri ile kapılarınızda hayat buluyor.

Kleon Line comes to life on your doors with its smooth lacquer surface and high-quality detail solutions.





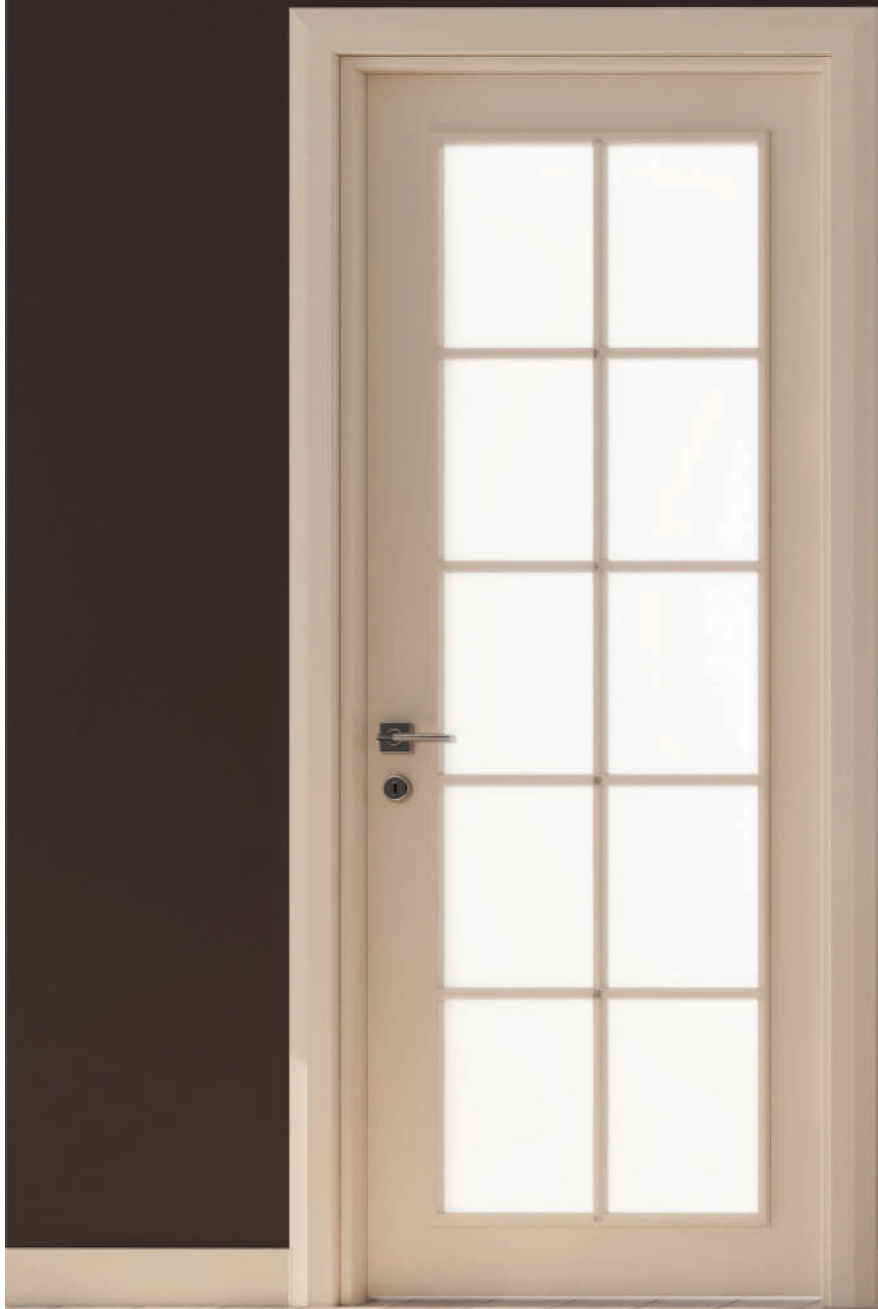



Performans Uygulamaları Performance Applications



Donanım Özellikleri Hardware Features

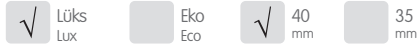

Kullanım Alanları Area of use

Otel / Hotel

Imperium Plus Daire Giriş Kapısı
Imperium Plus Flat Entrance Door

Sparta 8 & Sparta 9 Çelik Kapı Giydirme Uygulaması
Sparta 8 & Sparta 9 Steel Door Wood Panel Applications

Öneriler Suggestions

*Kleon Line serisi kapıların, dış hava koşullarına direkt olarak maruz kalınan noktalarda kullanılması kesinlikle önerilmemektedir. Sundurma, rüzgarlık, gölgelik ve benzeri yarı korumalı sistemlerden sonra giriş kapısı olarak kullanılabilir.

It is not recommended to use Kleon Line series doors in places exposed directly to weather condition. Can only be used, if door location is protected from weather conditions by porch, shade etc.



CK G10
Fildişi / Ivory

Renk Seçenekleri Color Alternatives



*Kleon Line ürün grubunda UV lake boya ve tüm yardımcı ürünlerde



kullanılmaktadır.

Donanım Renk Seçenekleri Hardware Color Alternatives



Uygulanabilir Modeller Styles

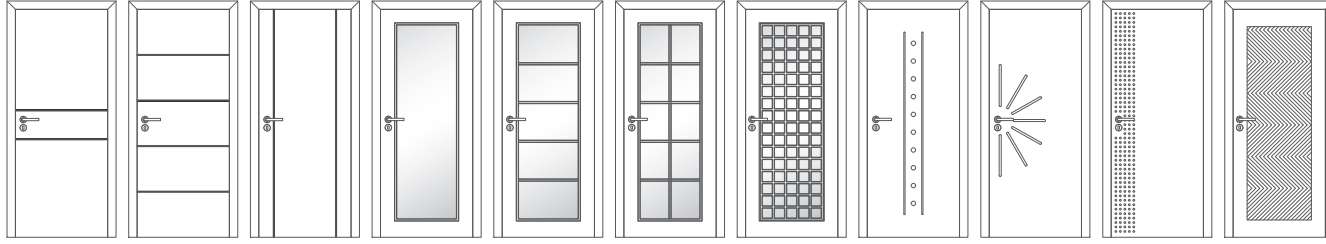

KL 9F1 KL 9F2 KL 9F3 CK G CK G5 CK G10 CK G75 KL 170 KL 180 KL 190 KL 200

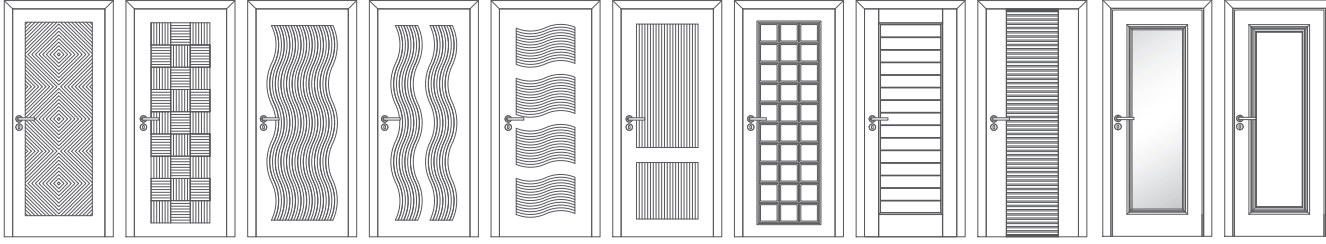

KL 210 KL 220 KL 230 KL 240 KL 250 KL 260 KL 280 KL 400 KL J01 CK 13L KL 13L
(KANAT RENGİNDE ÇİTALI)

Profil Detayı Door Profile Details

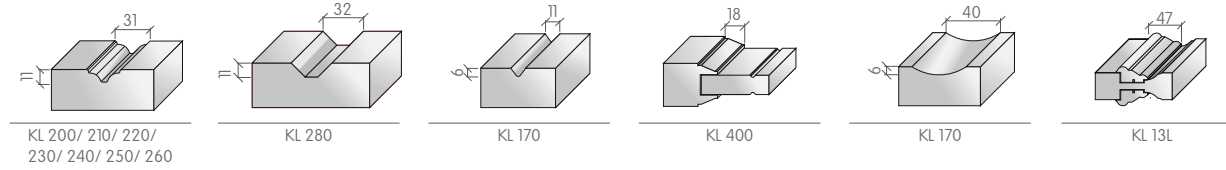

KL 200/ 210/ 220/
230/ 240/ 250/ 260

KL 280

KL 170

KL 400

KL 170

KL 13L

Standart Donanım Standard Hardware



Saplama menteşe
Drill-in hinge

Oda tipi kilit
Mortise lock cipher
bit (cb)

Wc tipi kilit
Mortise lock bathroom
/wc (wc)

Fişek sürgü
Flush bolt

Opsiyonel Donanım Optional Hardware



Yaprak menteşe
Butt hinge

Pivot Menteşe
Pivot hinge

Stoper
Door buffer

Barelli kilit
Mortise lock profilu
cylinder (pc)

Kasa - Pervaz seçenekleri Frame - Architrave options

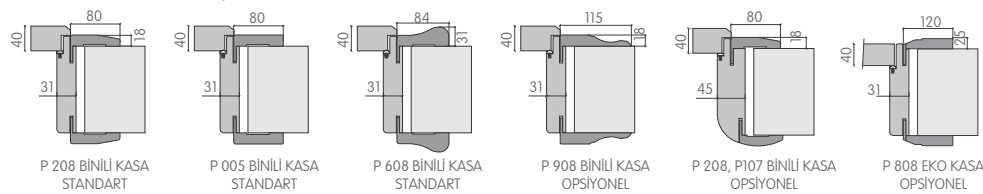

P 208 BİNİLİ KASA
STANDART

P 005 BİNİLİ KASA
STANDART

P 608 BİNİLİ KASA
STANDART

P 908 BİNİLİ KASA
OPSİYONEL

P 208, P107 BİNİLİ KASA
OPSİYONEL

P 808 EKO KASA
OPSİYONEL

Cam Uygulama Detayı Glazing Details

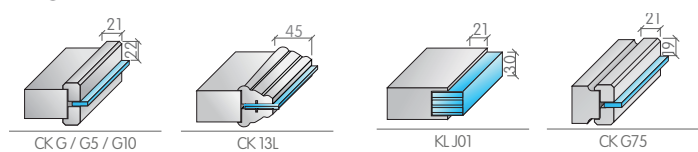

CK G / G5 / G10

CK 13L

KL J01

CK G75

*KL 400, KLJ 01 model kapılar düz kanatlı (binisiz) üretilir.

Fronia

Fronia hayal edebildiğiniz tüm renkleri UV lake teknoloji ile yaşadığınız mekanlara taşıyor.

Fronia brings all the colors you can imagine to the places you live with UV lacquer technology.





wish

Always
remember
to fall
asleep with
a dream
and wake
up with a
purpose

Big happy
dreams.





Performans Uygulamaları Performance Applications



Donanım Özellikleri Hardware Features



Kullanım Alanları Area of use

Otel / Hotel
Imperium Plus Daire Giriş Kapısı
Imperium Plus Flat Entrance Door

Sparta 8 & Sparta 9 Çelik Kapı Giydirme Uygulaması
Sparta 8 & Sparta 9 Steel Door Wood Panel Applications

Öneriler Suggestions

*Fronia serisi kapıların, dış hava koşullarına direkt olarak maruz kalınan noktalarda kullanılması kesinlikle önerilmemektedir. Sundurma, rüzgarlık, gölgelik ve benzeri yarı korumalı sistemlerden sonra giriş kapısı olarak kullanılabilir.

It is not recommended to use Fronia series doors in places exposed directly to weather condition. Can only be used, if door location is protected from weather conditions by porch, shade etc.



FR 190
Açık Mavi / Light Blue

Renk Seçenekleri Color Alternatives



Donanım Renk Seçenekleri Hardware Color Alternatives



Uygulanabilir Modeller Styles

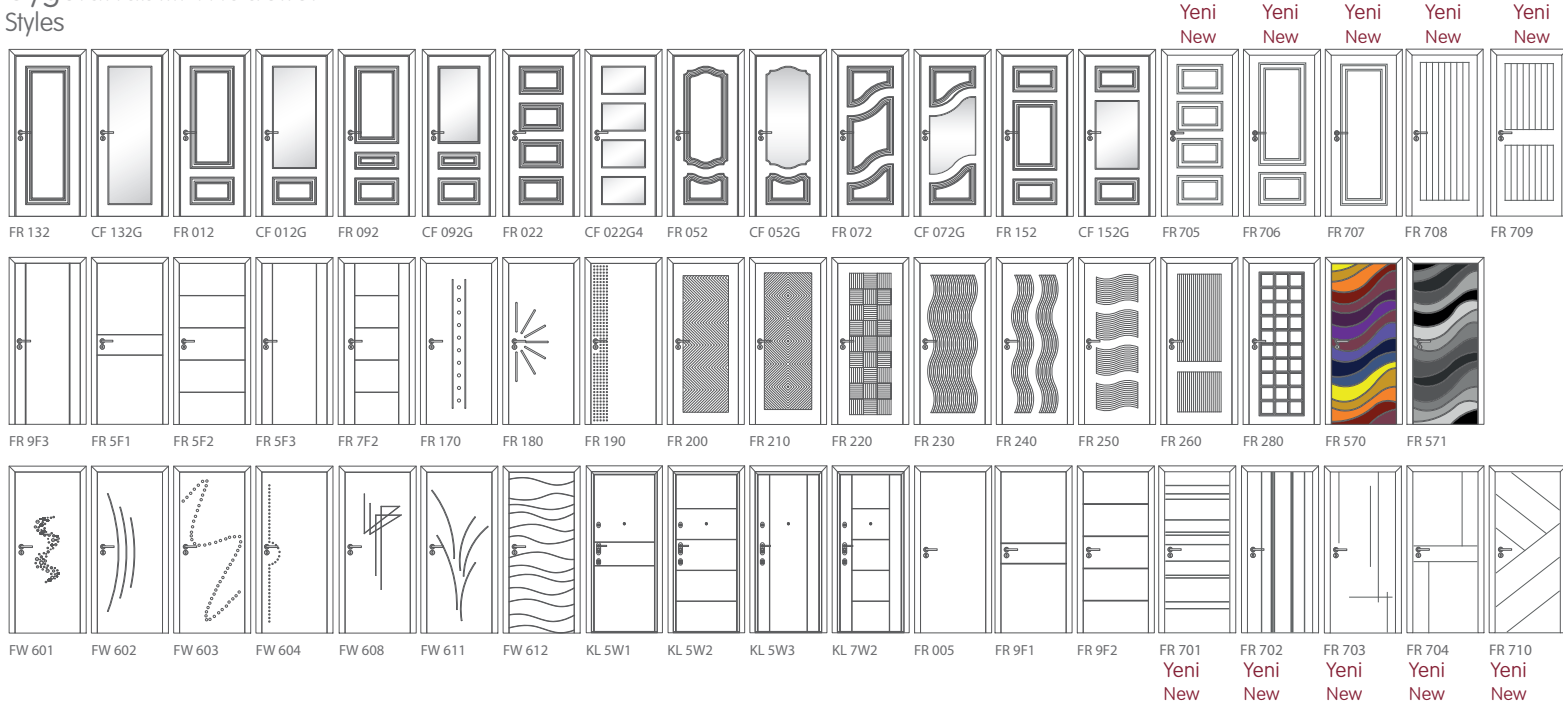

Profil Detayı Door Profile Details

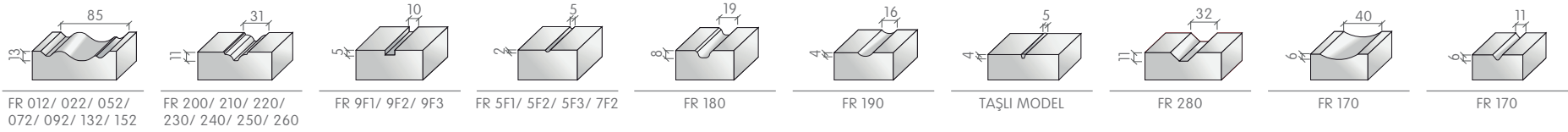

Standart Donanım Standard Hardware

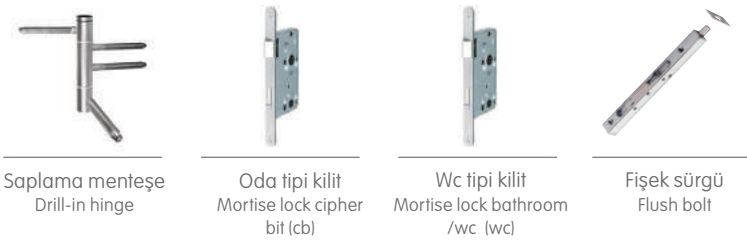

Kasa - Pervaz seçenekleri Frame - Architrave options

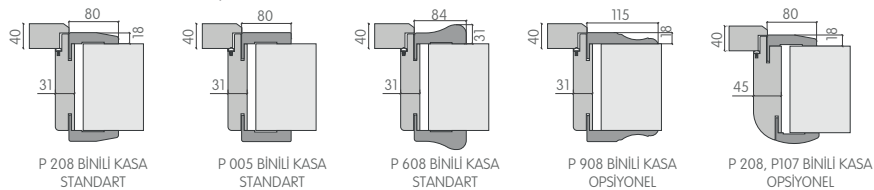

*FR 570 ve FR 571 modellerde kanatlar düz kanatlı üretilir.

Opsiyonel Donanım Optional Hardware



Cam Uygulama Detayı Glazing Details

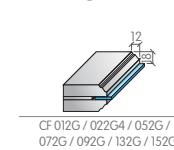

CF 012G / 022G4 / 052G / 072G / 092G / 132G / 152G

Natura

Natura İtalyan endüstriyel ahşap kaplamaların zengin renk seçenekleri ile modern uygulamalar sunuyor.

Natura offers the modern applications with rich color options of Italian industrial wood veneers.





Performans Uygulamaları Performance Applications

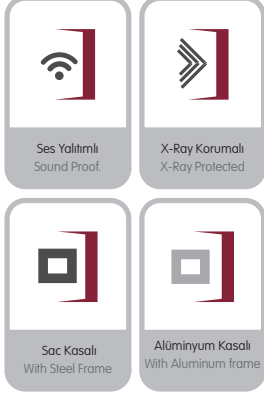

Donanım Özellikleri Hardware Features

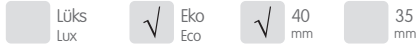

Kullanım Alanları Area of use

Otel / Hotel
Imperium Plus Daire Giriş Kapısı
Imperium Plus Flat Entrance Door

Sparta 8 & Sparta 9 Çelik Kapı Giydirme Uygulaması
Sparta 8 & Sparta 9 Steel Door Wood Panel Applications

Öneriler Suggestions

*Natura serisi kapıların, dış hava koşullarına direkt olarak maruz kalınan noktalarda kullanılması kesinlikle önerilmemektedir. Sundurma, rüzgarlık, gölgelik ve benzeri yarı korumalı sistemlerden sonra giriş kapısı olarak kullanılabilir.

It is not recommended to use Natura series doors in places exposed directly to weather condition. Can only be used, if door location is protected from weather conditions by porch, shade etc.



NA 7F2
Meşe / Oak

Renk Seçenekleri Color Alternatives



Donanım Renk Seçenekleri Hardware Color Alternatives



Uygulanabilir Modeller Styles

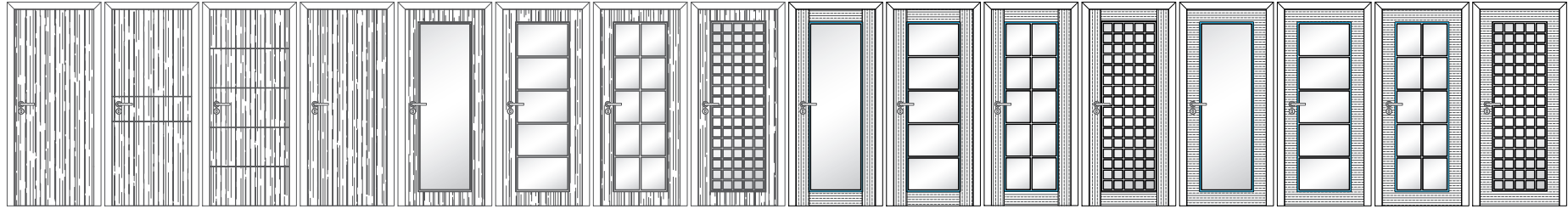

NA 005 NA 5F1 NA 5F2 NA 5F3 CN 105 G CN 105 G5 CN 105 G10 CN 105 G75 CN 107G CN 107G5 CN 107G10 CN 107G75 CN 106G CN 106G5 CN 106G10 CN 106G75



NA 006 NA 6F1 NA 6F2 NA 6F3 NA 007 NA 7F1 NA 7F2 NA 7F3 NA 008 NA J01

Profil Detayı Door Profile Details

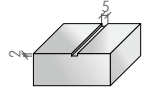

NA 5F1/ 5F2/ 5F3/
6F1/ 6F2/ 6F3/ 7F1/
7F2/ 7F3

Standart Donanım Standard Hardware



Düz menteşe
Flat hinge



Oda tipi kilit
Mortise lock cipher
bit (cb)



Wc tipi kilit
Mortise lock bathroom
/wc (wc)



Fişek sürgü
Flush bolt

Opsiyonel Donanım Optional Hardware



Barelli kilit
Mortise lock profilo
cylinder (pc)



Giyotin süpürgelik
Door bottom mobile
sill



Stoper
Door buffer



Hidrolik kapatıcı
Door closer

Kasa - Pervaz seçenekleri Frame - Architrave options

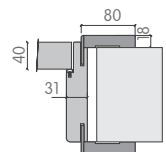

P 005 DÜZ KASA
STANDART

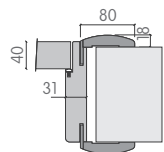

P 108 DÜZ KASA
OPSIYONEL

Cam Uygulama Detayı Glazing Details

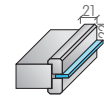

CN 105G / 105G5 / 105G10
105G75 / 106G / 106G5
106G10 / 106G75 / 107G
107G5 / 107G10 / 107G75

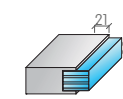

NA J01

Natura Royal

Natura Royal İtalyan endüstriyel ahşap kaplama teknolojisi ile ahşabın en seçkin klasik çizgilerini buluşturuyor.

Natura Royal combines the most outstanding classic lines of wood with Italian industrial wood coating technology.





Natura Royal

Performans Uygulamaları Performance Applications

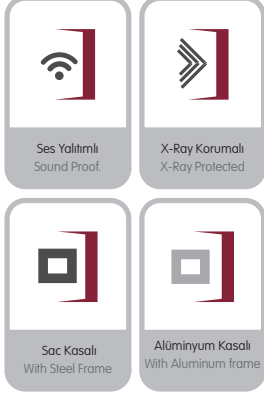

Donanım Özellikleri Hardware Features

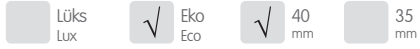

Kullanım Alanları Area of use

Otel / Hotel
Imperium Plus Daire Giriş Kapısı
Imperium Plus Flat Entrance Door

Sparta 8 & Sparta 9 Çelik Kapı Giydirme Uygulaması
Sparta 8 & Sparta 9 Steel Door Wood Panel Applications

Öneriler Suggestions

*Natura Royal serisi kapıların, dış hava koşullarına direkt olarak maruz kalınan noktalarda kullanılması kesinlikle önerilmemektedir. Sundurma, rüzgarlık, gölgelik ve benzeri yarı korumalı sistemlerden sonra giriş kapısı olarak kullanılabilir.

It is not recommended to use Natura Royal series doors in places exposed directly to weather condition. Can only be used, if door location is protected from weather conditions by porch, shade etc.



NA 024
Sütlü Kahve / Coffee Milk

Renk Seçenekleri Color Alternatives



Donanım Renk Seçenekleri Hardware Color Alternatives



Uygulanabilir Modeller Styles



NA 014 CN 014 G CN 014 G4 NA 234 CN 234 G CN 234 G5 NA 094 CN 094 G NA 024 CN 024 G4 NA E01 NA E02 NA E03 NA E04

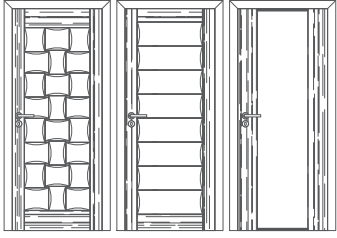

NA D01 NA D02 NA D03

Profil Detayı Door Profile Details

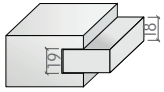

NA 014/ 024/ 094
234/ E01/ E02/ E03
E04/ D01/ D02/ D03

Standart Donanım Standard Hardware



Düz menteşe
Flat hinge



Oda tipi kilit
Mortise lock ciphher
bit (cb)



Wc tipi kilit
Mortise lock bathroom
/wc (wc)



Fişek sürgü
Flush bolt

Opsiyonel Donanım Optional Hardware



Barelli kilit
Mortise lock profilo
cylinder (pc)



Giyotin süpürgelik
Door bottom mobile
sill



Stoper
Door buffer



Hidrolik kapatıcı
Door closer

Kasa - Pervaz seçenekleri Frame - Architrave options

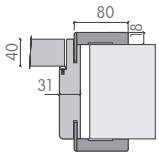

P 005 DÜZ KASA
STANDART

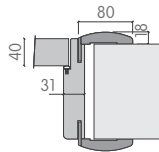

P 108 DÜZ KASA
OPSIYONEL

Cam Uygulama Detayı Glazing Details

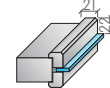

CN 105G / 105G5 / 105G10
105G75 / 106G / 106G5
106G10 / 106G75 / 107G
107G5 / 107G10 / 107G75

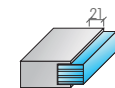

NA J01

Organica

Organica İtalyan doğal ahşap kaplamanın ayrıcalığını tüm sıcaklığı ile evinize taşıyor.

Organica carries the privilege of Italian natural wood coating to your home.





Performans Uygulamaları Performance Applications



Donanım Özellikleri Hardware Features



Kullanım Alanları Area of use

Otel / Hotel

Imperium Plus Daire Giriş Kapısı
Imperium Plus Flat Entrance Door

Sparta 8 & Sparta 9 Çelik Kapı Giydirme Uygulaması
Sparta 8 & Sparta 9 Steel Door Wood Panel Applications

Öneriler Suggestions

*Organica serisi kapıların, dış hava koşullarına direkt olarak maruz kalınan noktalarda kullanılması kesinlikle önerilmemektedir. Sundurma, rüzgarlık, gölgelik ve benzeri yarı korumalı sistemlerden sonra giriş kapısı olarak kullanılabilir.

It is not recommended to use Organica series doors in places exposed directly to weather condition. Can only be used, if door location is protected from weather conditions by porch, shade etc.

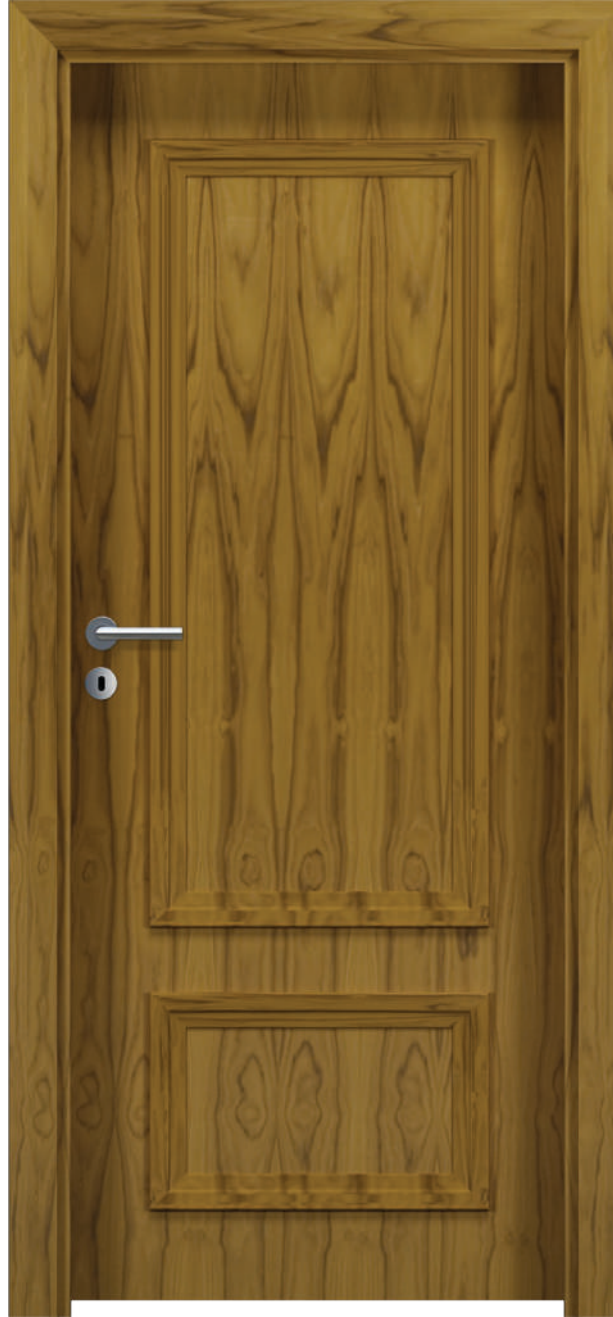

OL 015
Teak / Oak

Renk Seçenekleri Color Alternatives

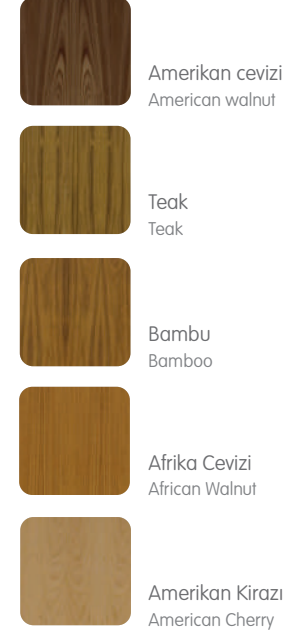

Donanım Renk Seçenekleri Hardware Color Alternatives



Uygulanabilir Modeller Styles

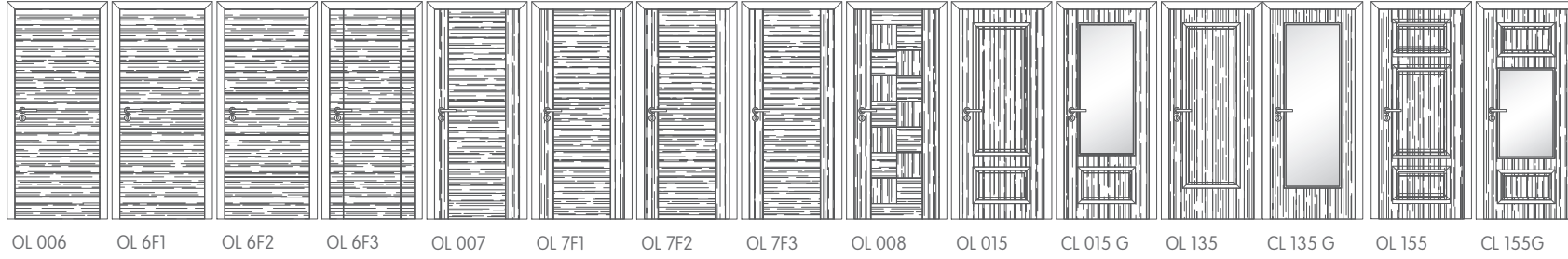
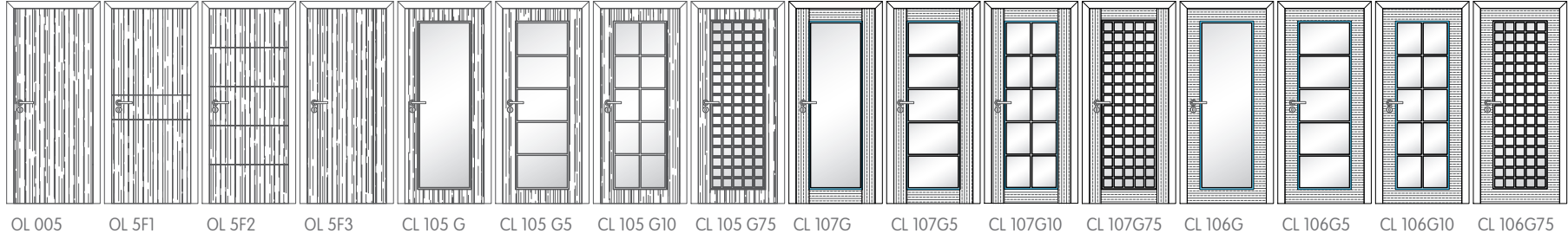

Profil Detayı Door Profile Details

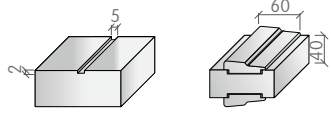

OL 5F1/ 5F2/ 5F3/ 6F1/
6F2/ 6F3/ 7F1/ 7F2/ 7F3

OL 015/ 135/ 155

Standart Donanım Standard Hardware



Yaprak menteşe
Butt hinge



Oda tipi kilit
Mortise lock ciphher
bit (cb)



Wc tipi kilit
Mortise lock bathroom
/wc (wc)



Fişek sürgü
Flush bolt

Opsiyonel Donanım Optional Hardware



Barelli kilit
Mortise lock profilo
cylinder (pc)



Gizli menteşe
Concealed hinge
*45 mm'lik kasada kullanılır.



Stoper
Door buffer



Pivot Menteşe
Pivot hinge

Kasa - Pervaz seçenekleri Frame - Architrave options

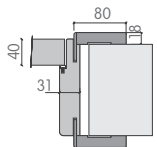

P 005 DÜZ KASA
STANDART

Cam Uygulama Detayı Glazing Details

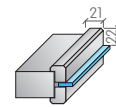

CL 105 G / CL 105 G5 / CL 105 G10
CL 105 G75 / CL 106 G / CL 106 G5
CL 106 G10 / CL 106 G75 / CL 107 G
CL 107 G5 / CL 107 G10 / CL 107 G75
CL 015 G / CL 135 G / CL 155 G

Organica Royal

Organica Royal İtalyan doğal ahşap kaplamanın en özgün renklerini klasik çizgilerle yorumluyor.

Organica Royal interprets the most original colors of Italian natural wood coating with classic lines.





Organica Royal

Performans Uygulamaları Performance Applications



Donanım Özellikleri Hardware Features



Kullanım Alanları Area of use

Otel / Hotel
Imperium Plus Daire Giriş Kapısı
Imperium Plus Flat Entrance Door

Öneriler Suggestions

*Organica Royal serisi kapıların, dış hava koşullarına direkt olarak maruz kalınan noktalarda kullanılması kesinlikle önerilmemektedir. Sundurma, rüzgarlık, gölgelik ve benzeri yarı korumalı sistemlerden sonra giriş kapısı olarak kullanılabilir.

It is not recommended to use Organica Royal doors in places exposed directly to weather condition. Can only be used, if door location is protected from weather conditions by porch, shade etc.



CR 026 G
Teak / Teak

Renk Seçenekleri Color Alternatives

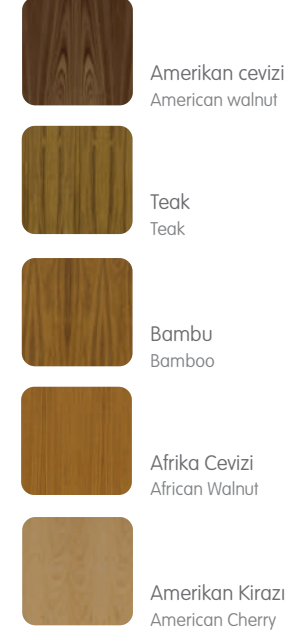

Donanım Renk Seçenekleri Hardware Color Alternatives



Uygulanabilir Modeller Styles

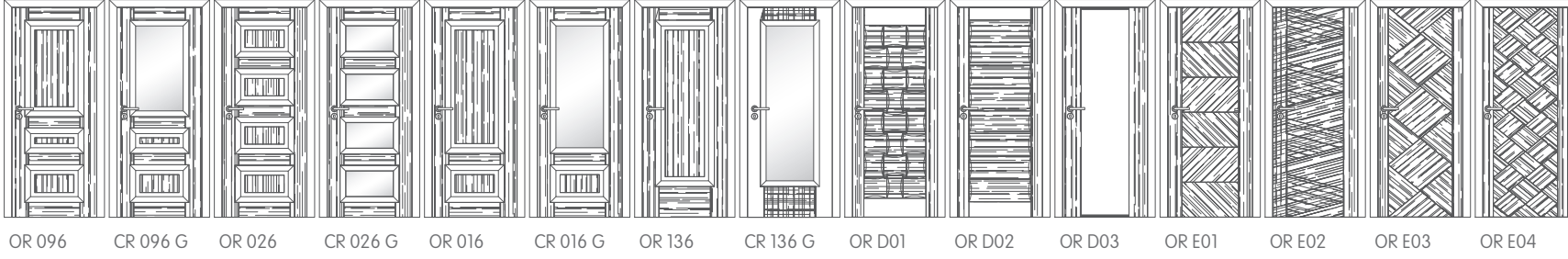

Profil Detayı Door Profile Details

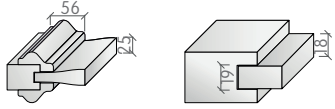

OR 016/ 026/ 096/ 136 OR E01/ E02/ E03/ E04
D01/ D02/ D03

Standart Donanım Standard Hardware



Yaprak menteşe
Butt hinge



Oda tipi kilit
Mortise lock ciphers
bit (cb)



Wc tipi kilit
Mortise lock bathroom
/wc (wc)



Fişek sürgü
Flush bolt

Opsiyonel Donanım Optional Hardware



Barelli kilit
Mortise lock profilo
cylinder (pc)



Gizli menteşe
Concealed hinge
*45 mm'lik kasada kullanılır.



Stoper
Door buffer



Pivot Menteşe
Pivot hinge

Kasa - Pervaz seçenekleri Frame - Architrave options

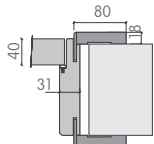

P 005 DÜZ KASA
STANDART

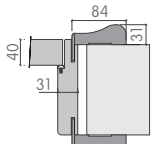

P 608 BİNLİ KASA
STANDART

Cam Uygulama Detayı Glazing Details

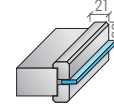

CL 105 G / CL 105 G5 / CL 105 G10
CL 105 G75 / CL 106 G / CL 106 G5
CL 106 G10 / CL 106 G75 / CL 107 G
CL 107 G5 / CL 107 G10 / CL 107 G75
CL 015 G / CL 135 G / CL 155 G

Lamina

Lamina hastane, okul, AVM vb. projelerde endüstriyel uygulamalar için geliştirilmiş uzun ömürlü çözümler sunuyor.

Lamina offers long-lasting solutions for industrial applications in projects such as, hospitals, schools, shopping malls, etc.





502

Lamina

Performans Uygulamaları Performance Applications

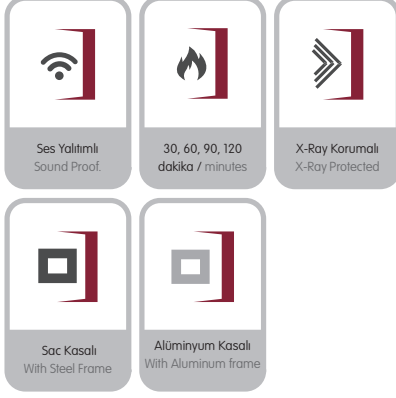

Donanım Özellikleri Hardware Features



Kullanım Alanları Area of use

Otel / Hotel

Imperium Plus Daire Giriş Kapısı
Imperium Plus Flat Entrance Door

Sparta 8 & Sparta 9 Çelik Kapı Giydirme Uygulaması
Sparta 8 & Sparta 9 Steel Door Wood Panel Applications

Öneriler Suggestions

*Lamina serisi kapıların, dış hava koşullarına direkt olarak maruz kalınan noktalarda kullanılması kesinlikle önerilmemektedir. Sundurma, rüzgarlık, gölgelik ve benzeri yarı korumalı sistemlerden sonra giriş kapısı olarak kullanılabilir.

It is not recommended to use Lamina series doors in places exposed directly to weather condition. Can only be used, if door location is protected from weather conditions by porch, shade etc.



CL 005 G2
Yeşil /Green

Renk Seçenekleri Color Alternatives



Donanım Renk Seçenekleri Hardware Color Alternatives



Uygulanabilir Modeller Styles



Profil Detayı Door Profile Details

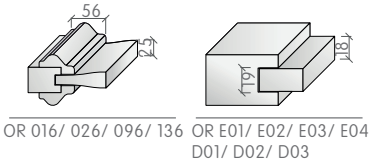

Standart Donanım Standard Hardware



Opsiyonel Donanım Optional Hardware



Kasa - Pervaz seçenekleri Frame - Architrave options

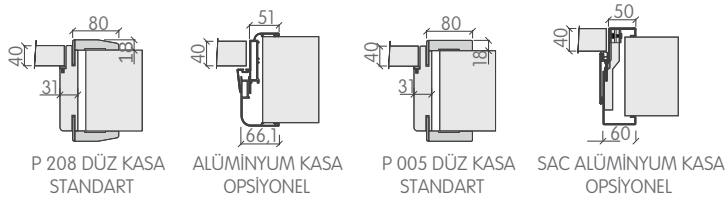

Cam Uygulama Detayı Glazing Details

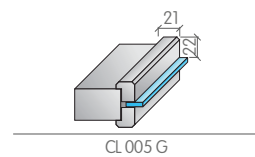

*Cam çıtası alüminyum olarak uygulanmaktadır.

Glazio

Glazio Cam ve ahşabı özel bir itina ile buluşturuyor.

Glazio offers long-lasting solutions for industrial applications in projects such as, hospitals, schools, shopping malls, etc.





Performans Uygulamaları Performance Applications



Donanım Özellikleri Hardware Features



Kullanım Alanları Area of use

Ofis / Office
Konut / Residence

Öneriler Suggestions

*Glazio serisi kapıların, dış hava koşullarına direkt olarak maruz kalınan noktalarda kullanılması kesinlikle önerilmemektedir. Sundurma, rüzgarlık, gölgelik ve benzeri yarı korumalı sistemlerden sonra giriş kapısı olarak kullanılabilir.

It is not recommended to use Glazio series doors in places exposed directly to weather condition. Can only be used, if door location is protected from weather conditions by porch, shade etc.



GK 005
Amerikan Ceviz / American Walnut

Renk Seçenekleri Color Alternatives



Donanım Renk Seçenekleri Hardware Color Alternatives



Uygulanabilir Modeller Styles

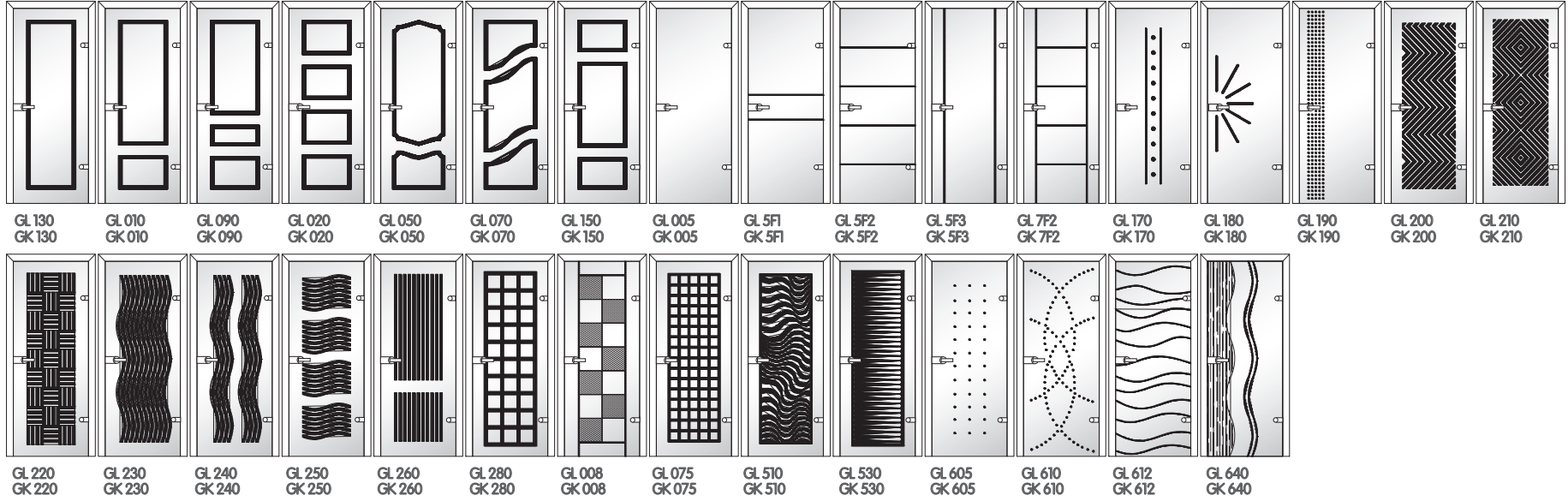

Profil Detayı Door Profile Details

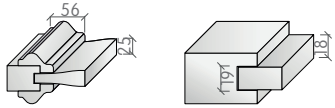

OR 016/ 026/ 096/ 136 OR E01/ E02/ E03/ E04
D01/ D02/ D03

Standart Donanım Standard Hardware



Menteşe
Hinge

Oda tipi kilit
Mortis lock
cipher bit (cb)

Opsiyonel Donanım Optional Hardware



Arcos menteşe
Arcos hinge

Rondo menteşe
Rondo hinge

Gala menteşe
Gala hinge

Junior office menteşe
Junior office hinge

Arcos kilit - Kol
Arcos lock - Handle

Rondo kilit - Kol
Rondo lock - Handle

Kasa - Pervaz seçenekleri Frame - Architrave options

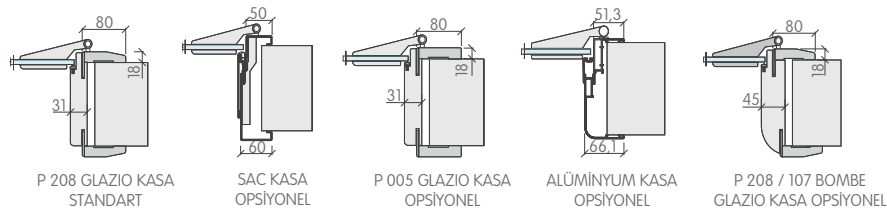

Panora

Panora Toplu konut projeleri için geliştirilmiş özel bir seri olarak hızlı üretim, kolay montaj ve ekonomik bir çözüm sunuyor.

Panora offers long-lasting solutions for industrial applications in projects such as, hospitals, schools, shopping malls, etc.





Panora

Performans Uygulamaları Performance Applications



Donanım Özellikleri Hardware Features



Kullanım Alanları Area of use

Otel / Hotel
Imperium Plus Daire Giriş Kapısı
Imperium Plus Flat Entrance Door

Öneriler Suggestions

*Panora serisi kapıların, dış hava koşullarına direkt olarak maruz kalınan noktalarda kullanılması kesinlikle önerilmemektedir. Sundurma, rüzgarlık, gölgelik ve benzeri yarı korumalı sistemlerden sonra giriş kapısı olarak kullanılabilir.

It is not recommended to use Panora series doors in places exposed directly to weather condition. Can only be used, if door location is protected from weather conditions by porch, shade etc.



CA 005 G
Beyaz / White

Renk Seçenekleri Color Alternatives

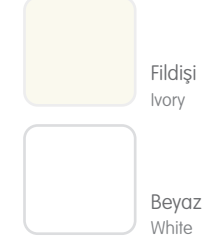

Donanım Renk Seçenekleri Hardware Color Alternatives



Uygulanabilir Modeller Styles



Profil Detayı Door Profile Details

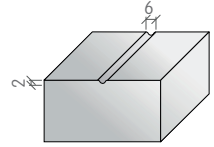

PA 5F1 / PA 5F2
PA 5F3 / PA 7F2

Standart Donanım Standard Hardware



Düz menteşe
Butt hinge



Sessiz kilit
Mortise lock



Sürgü fişek
Flush bolt

Opsiyonel Donanım Optional Hardware



Barelli kilit
Mortise lock profilo
cylinder (pc)



Gizli menteşe
Concealed hinge
*45 mm'lik kasada kullanılır.



Stoper
Door buffer



Giyotin
Door bottom
mobile sill



Hidrolik kapatıcı
Hydraulic closers



Çarpma kapı
menteşesi

Kasa - Pervaz seçenekleri Frame - Architrave options

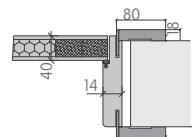

P 005 DÜZ KASA
STANDART

Cam Uygulama Detayı Glazing Details

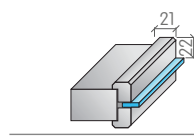

CA 005 G / CA 205 G

İç Kapı Detayları

Interior Door Details

Açılım Seçenekleri Door Opening Options



Tek Kanat
Single leaf



Yavru Kanatlı
Double leaf
(asymmetric)



Çift Kanatlı
Double leaf
(equal)



Tek Kanat Katlanır
Folding door
single leaf



Çift Kanat Katlanır
Folding door
double leaf



Tek Kanat Çarpma
Double action
swing door
single leaf



Çift Kanat Çarpma
Double action
swing door
double leaf



Tek Kanat İçten Sürme
In-wall sliding door
single leaf

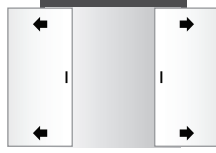

Çift Kanat İçten Sürme
In-wall sliding door
double leaf

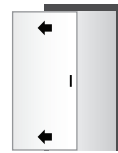

Tek Kanat Dıştan Sürme
Out-wall sliding door
single leaf

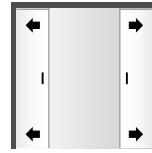

Çift Kanat Dıştan Sürme
Out-wall sliding door
double leaf

Sabit Bölme Uygulamaları Fixed transform and side panel applications



Tek Kanat /Single leaf



Yavru Kanatlı /Double leaf (asymmetric)



Çift Kanatlı /Double leaf (equal)



Tek Kanat /Single leaf



Yavru Kanatlı /Double leaf (asymmetric)



Çift Kanatlı /Double leaf (equal)

Pervaz birleşim Architrave joints

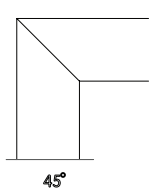

45°

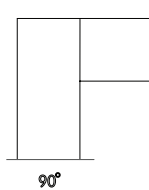

90°

Min-max ölçüler Min-max dimensions

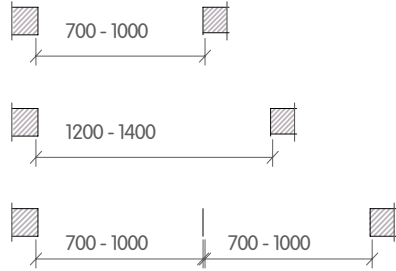

- Yavru kanadın camlı olması durumunda minimum ölçü 350 mm olarak uygulanmaktadır.
- In asymmetric double leaf doors the minimum width for the smaller leaf shall be 350 mm.

Standart ölçüler Standard dimensions

Genişlik / Width (mm)

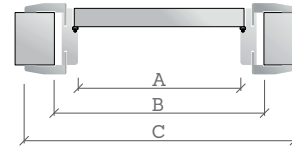

Tek kanatlı kapı
single leaf door



Yavru kanatlı kapı
One and a half leaf door



Çift kanatlı kapı
double leaf door



A B C

610	700	814
660	750	864
710	800	914
760	850	964
810	900	1014

1110	1200	1314
1210	1300	1414
1310	1400	1514

1510	1600	1714
1610	1700	1814
1710	1800	1914

Adaptör Kasa Uygulaması Application Adaptor Box

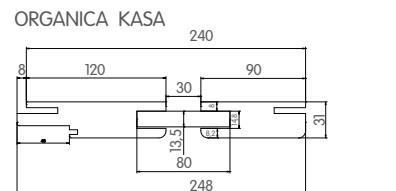
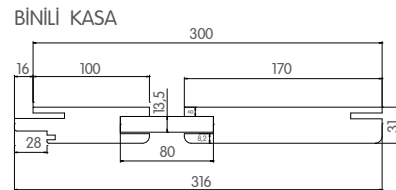
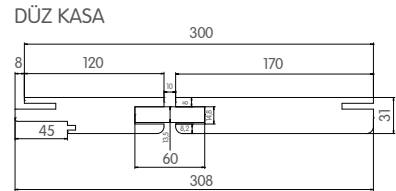

- Duvar kalınlığının 200 mm'yi geçmesi durumunda adaptör uygulaması yapılır.
- Exceed 200 mm in case the thickness of the wall adapter is applied.

Yükseklik / Height (mm)

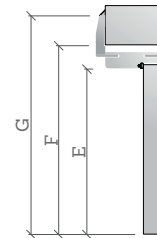

Tek kanat kapı
single leaf door



Yavru kanatlı kapı
One and a half leaf door



Çift kanatlı kapı
double leaf door



E F G

1855	1900	1957
1905	1950	2007
1955	2000	2057
2005	2050	2107
2055	2100	2157

Duvar Kalınlığı / Wall thickness (mm)



Tek kanat kapı
single leaf door



Yavru kanatlı kapı
One and a half leaf door



Çift kanatlı kapı
double leaf door



D D'

100	115
120	135
140	155
160	175
180	195
200	215

Performans Uygulamaları / Performance Applications

Yangın Dayanımlı Kapılar
Fire Rated Doors

X-ray Korumalı Kapılar
X-ray protected doors

Ses Yalıtımlı Kapılar
Sound proof doors

Alüminyum Kasalı Kapılar
Doors with aluminum frames

Sac Kasalı Kapılar
Doors with steel frames

30 Dakika Yangın Dayanımlı Ahşap Kapı

30 Minutes fire rated wooden door applications

Standart Donanım Standard Hardware



Yangın dayanımlı kilit
Fire-rated lock



Yangın dayanımlı kapı kolu
Fire-rated door handle



Özel giyotin süpürgelik
Door mobile bottom sill

Uygulanabilen Seriler Available Series



Organica



Natura



Lamina



Organica Royal
*Opsiyonel



Natura Royal
*Opsiyonel



Kleon
*Opsiyonel

Sertifika Özellikleri Suggestions

*İlgili ürün gruplarındaki 005 modeli ve tüm fugalı, çıtalı modeller (camsız kapılar) modelleriyle birlikte 30 dk yangın dayanımlı olarak üretilebilmektedir. 30 dk yangın dayanımlı özel menteşe, kilit, kol, yangın fitili ve duman fitili ile sunulmaktadır. Kanatta DorteK monoblok-dolu lif levha kullanılmaktadır ve kanat kalınlığı 44 mm olmaktadır.

For the relevant product series all solid styles (Except glazio, Natura Royal and Organica Royal series) are available with 30 Min. fire-rating feature.

30 Min fire-rated doors are supplied with special fire-rated hinges, lock, handle, fire and smoke seals.

Leaf structure is standard DorteK solid-monoblock fiberboard with the thickness of 44 mm.

Kasa Pervaz Detayı Area of use

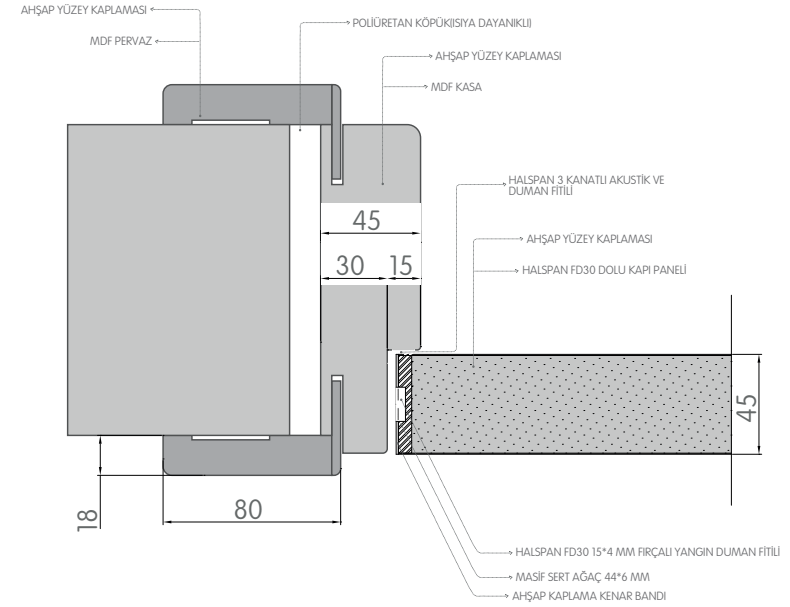

Opsiyonel Donanım Optional Hardware

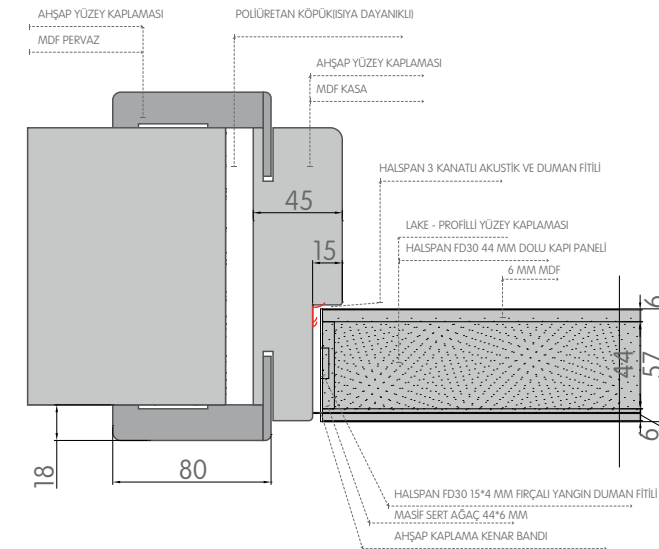

90 Dakika Yangın Dayanımlı Ahşap Kapı

90 Minutes fire rated wooden door applications

Standart Donanım Standard Hardware



Yangın dayanımlı kilit
Fire-rated lock



Yangın dayanımlı
kapı kolu
Fire-rated door handle



Özel giyotin
süpürgelik
Door mobile bottom sill

Uygulanabilen Seriler Available Series



Organica



Natura



Lamina

Kasa Pervaz Detayı Area of use

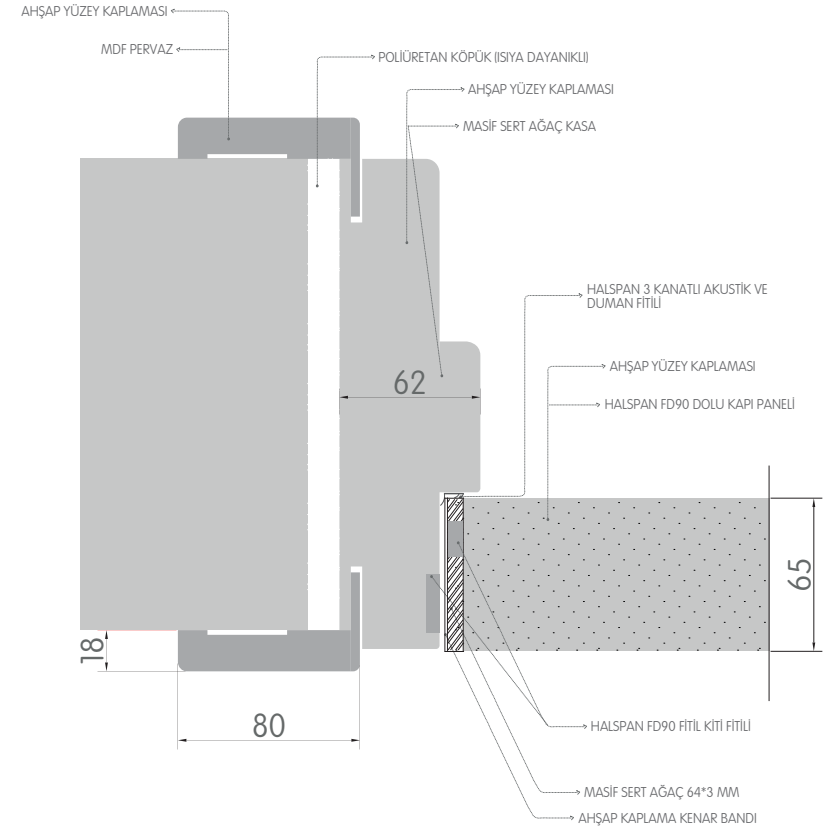

Sertifika Özellikleri Suggestions

*İlgili ürün gruplarındaki düz 005 modeller ve özel camlı uygulamalı modeller 90 dk yangın dayanımlı olarak üretilmektedir. 90 dk yangın dayanımlı Halspan F120 menteşe, kilit, kol, yangın fitili ve duman fitili ile sunulmaktadır. Halspan 64 mm levhadan üretilmektedir.

For the relevant product series, only 005 door styles and styles with strip cuts are available with 90 Min. fire rating feature. 90 Min. fire rated doors are supplied with special fire rated hinges, lock, handle, fire and smoke seals. The leaf thickness is 64 mm.

120 Dakika Yangın Dayanımlı Ahşap Kapı

120 Minutes fire rated wooden door applications

Standart Donanım Standard Hardware



Yangın dayanımlı kilit
Fire-rated lock

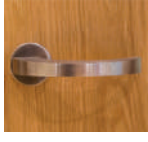

Yangın dayanımlı
kapı kolu
Fire-rated door handle



Özel giyotin
süpürgelik
Door mobile bottom sill

Uygulanabilen Seriler Available Series



Organica



Natura



Lamina

Kasa Pervaz Detayı Area of use

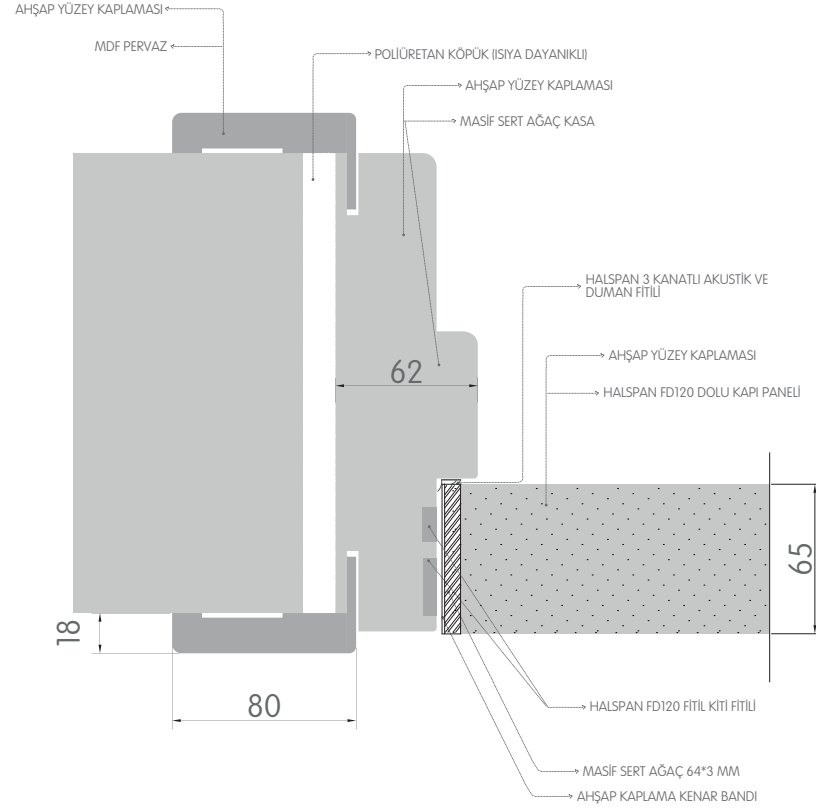

Sertifika Özellikleri Suggestions

*İlgili ürün gruplarındaki düz 005 modeller ve özel camlı uygulamalı modeller 120 dk yangın dayanımlı olarak üretilmektedir. 120 dk yangın dayanımlı Halspan F120 menteşe, kilit, kol, yangın fitili ve duman fitili ile sunulmaktadır. Halspan 64 mm levhadan üretilmektedir.

For the relevant product series, only 005 door styles and styles with strip cuts are available with 120 min. fire rating feature. 120 min. fire rated doors are supplied with special fire rated hinges, lock, handle, fire and smoke seals. The leaf thickness is 64 mm.

X-Ray Korumalı Kapılar

X-Ray protected doors

Standart Donanım Standard Hardware



Sac kasa menteşesi
Steel frame hinge



Çift barelli kilit
Double mortise lock with
Profile cylinder (pc)



Kilit
Lock



Giyotin süpürgelik
Door bottom mobile sill

Kasa Pervaz Detayı Area of use

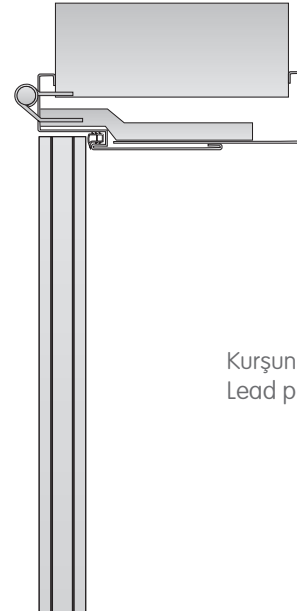
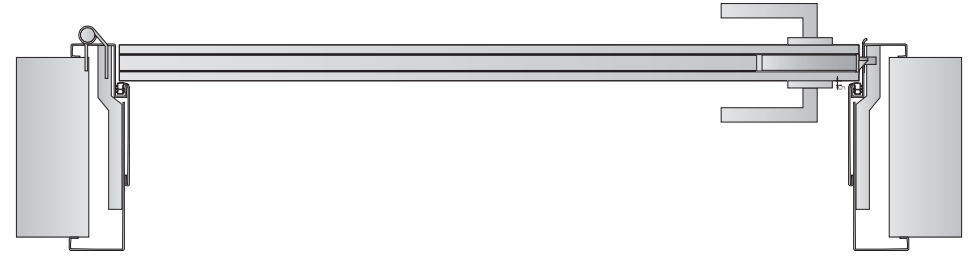

Kurşun Plaka
Lead plate

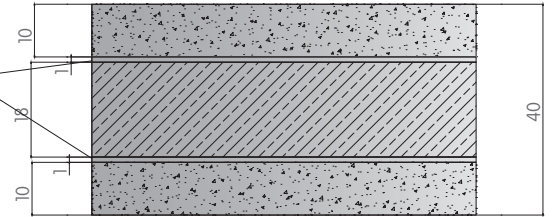

Uygulanabilen Seriler Available Series



Optima Plus



Organica Line



Maksima Plus



Lamina



Divio



Fronia



Diviov Line



Natura Line



Kleon



Kleon Line

Donanım Renk Seçenekleri Optional Hardware



Sertifika Özellikleri Suggestions

* İlgili ürün gruplarındaki kapılardan, düz 005 modelleri ve tüm fugalı modeller X-Ray korumalı olarak üretilmektedir. Dörtke monoblok-dolu lif levha kullanılmaktadır. 40 mm kalınlığındaki kanat, 10+18+10 mm kalınlığında üç katman olarak çalışılır ve katmanlar arasında 1mm kurşun plaka yerleştirilir. Kanat yüzeyi, ilgili ürün gruplarındaki yüzey bitişine uygun olarak sonlandırılır. Giyotin süpürgelik, çift barelli kilit, yarım baryl, özel sac kasa menteşesi ve iç yüzeyine kurşun plaka yerleştirilmiş özel sac kasa ile sunulmaktadır.

For the relevant product series, only 005 door styles and styles with stripcuts are available. Solid-monoblock fiberboard door leaf with the thickness of 40 mm consist of three layers with the thickness of 10+18+10 mm. two leaf plates are imlaid between the layers. The leaf surface is finished according to the surface finish of the relevant product groups. They are provided with door bottom mobile sill, single profile cylinder, special steel frame hinge and special steel frame with lead plate in the inner surface.

Standart Donanım

Standard Hardware



Yaprak menteşe
Butt hinge



Barelli kilit
Mortise lock
Profile cylinder (pc)



Giyotin süpürgelik
Door bottom mobile sill

Uygulanabilen Seriler

Available Series



Optima Plus



Organica Line



Maksima Plus



Lamina



Divio



Fronia



Diviov Line



Natura Line



Kleon



Kleon Line

Kasa Pervaz Detayı

Area of use

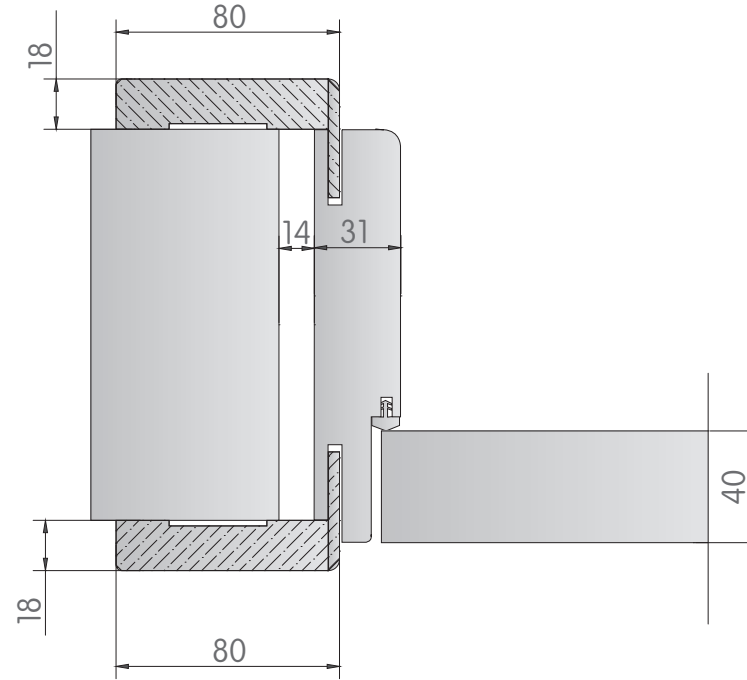
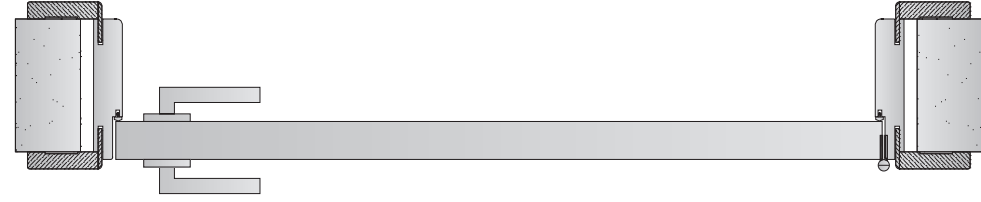

Donanım Renk Seçenekleri

Optional Hardware



Sertifika Özellikleri

Suggestions

* İlgili ürün gruplarındaki tüm dolu kapılar (camsız kapılar) modelleriyle birlikte 42dB Meyer sertifikalı ses yalıtımlı olarak üretilmektedir. Dörttek monoblok-dolu lif levha kullanılmaktadır. Kanat kalınlığı 40 mm, kasa kalınlığı 45 mm olmaktadır. Ses izolasyonlu özel giyotin süpürgelik ile sunulmaktadır. Üretilen kapının ses yalıtım özelliğini kusursuz sağlaması için montaj aşaması çok önemlidir. Kasa ve duvar yüzeyi arasında kalan montaj boşluğunun, poliüretan montaj köpüğü ile boşluk kalmayacak şekilde doldurulması gerekmektedir.

All solid (unglazed) door styles within the relevant product series, are available with Meyer certified 42 dB soundproof feature. Dörttek solid monoblock fiberboard is used. The thickness of the leaf is 40 mm and the thickness of the frame is 45 mm. Soundproof doors are supplied with sound door bottom mobile sill. The installation gap between the frame and wall surface must be completely filled with polyurethane installation foam by leaving no gaps.

Alüminyum kasalı kapılar

Doors with aluminum frame

Standart Donanım Standard Hardware



Yaprak menteşe
Butt hinge



Barelli kilit
Mortise lock profile
cylinder (pc)

Kasa Pervaz Detayı Area of use



Uygulanabilen Seriler Available Series



Optima Plus



Organica Line



Maksima Plus



Lamina



Divio



Fronia



Diviov Line

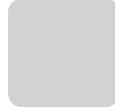

Natura Line



Kleon



Kleon Line

Donanım Renk Seçenekleri Optional Hardware



Paslanmaz Çelik
Stainless Steel



Parlak Krom
Chrome Polished



Mat Krom
Chrome Matt



Pirinç
Brass

Sertifika Özellikleri Suggestions

* İlgili ürün platformlarındaki camlı ve dolu tüm kapılar, alüminyum kasalı olarak üretilebilmektedir. Kanat kalınlığı 40 mm ve kanat tipi de düz olarak üretilmektedir.

All glazed and solid styles within the relevant product series can be manufactured with aluminum frame. Doors with aluminum frame have 40 mm thick flush (not rebated) leaves.

Standart Donanım Standard Hardware



Menteşe
Hinge



Barelli kilit
Mortise lock Profile
cylinder (pc)

Kasa Pervaz Detayı Area of use

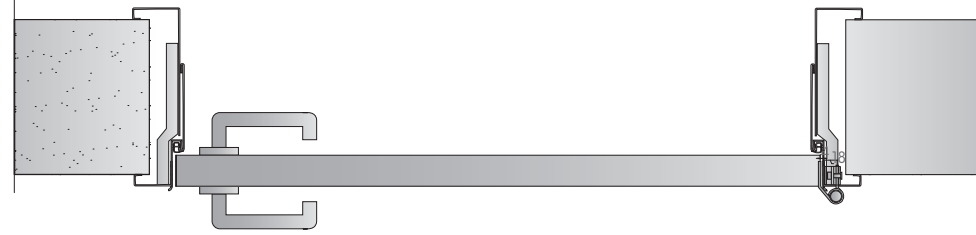

Uygulanabilen Seriler Available Series



Optima Plus



Organica Line



Maksima Plus



Lamina



Divio



Fronia



Diviov Line



Natura Line



Kleon



Kleon Line

Donanım Renk Seçenekleri Optional Hardware



Paslanmaz Çelik
Stainless Steel



Parlak Krom
Chrome Polished



Mat Krom
Chrome Matt



Pirinç
Brass

Sertifika Özellikleri Suggestions

* İlgili ürün platformlarındaki camlı ve dolu tüm kapılar, sac kasalı olarak üretilmektedir. Platform standart ürün özelliklerinden farklı olarak kapılar, sac kasa özel menteşesi ile sunulmaktadır. Kanat kalınlığı 40mm ve kanat tipi de düz olarak üretilmektedir.

All glazed and solid styles within the relevant product platforms can be manufactured with steel frame. In addition to the standard product features of the series, the doors with steel frame are supplied with special hinges. Doors with steel frame have 40 mm thick flush (not rebated) leaves.

Yangın Kapısı

Fire Doors

Okul, hastane, otel, ofis vb. projeler için uluslararası norm ve sertifikasyonda profesyonel çözüm...

A professional solution with international norm and certification for projects such as schools, hospitals, offices etc.



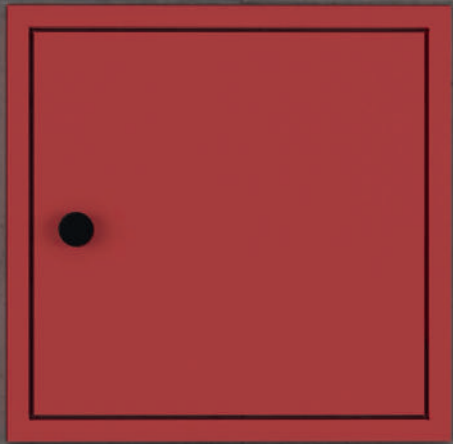

Metal Yangın Kapısı Teknik Özellikleri

Fire escape doors / EI 60 - EI 120

Standart Donanım Standard Hardware



Kilit
Lock



Standart siyah kol
Standard black door
handle

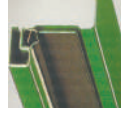

Fitil
Seal



Sabit pim
Fixed pin



Termik kasa
Thermic frame

Opsiyonel Donanım Optional Hardware



Sertifikalı yangın
camı
Certified fire rated glass



Giyotin süpürgelik
Door bottom sill

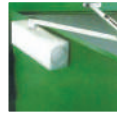

Hidrolik kapatıcı
Door closer



Manyetik tutucu
Magnetic holder



Panik bar
Panic bar

- Patenli Termik Yarım Kasa, yangın anında ısı iletimini duvarlara yansıtarak, önemli ölçüde azaltılmak amacıyla tasarlanmıştır.
- Galvanizli çelik levha ile kaplı yüzey, dış etkenlere karşı üstün koruma ve estetik görünüş sağlamak için toz boya ile kaplanmıştır.
- Kasanın 3 tarafına içten yerleştirilen sıcak duman fitilleri, yangın anında şişerek izolasyon sağlar.
- Kapı kanadının içinde yangın dayanım sertifikalı özel bir dolgu bulunmaktadır.

- Patented Thermal Half Frame is designed to significantly decrease the heat by reflecting the heat to the walls in case of any fire.
- The surface coated with galvanized steel plate is coated with powder coat in order to ensure outstanding protection against external factors and esthetic appearance.
- The hot smoke beads placed within the frame on 3 sides provide insulation by swelling during fire.
- There is a fire rate certified special filling within the door leaf.

Uygulanabilir Renkler Available Styles

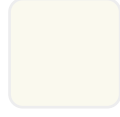

Fildişi
Ivory



Gri
Gray

Farklı RAL renkleri opsiyonel olarak uygulanabilmektedir.
Standart dışı ölçüler opsiyonel olarak uygulanabilmektedir.

Different RAL colors are applied optionally.
Non-standard sizes are applied optionally.

Standart Özellikler Standard Specifications

- + Avrupa Birliği normlarına uygun, UNI 9723 standardında EI 60 ve EI 120 yangın dayanım sertifikası.
- + Galvanize çelik, ankrajlı, ısı geçirgen termik kasa.
- + Galvanize sac içinde "L" biçimli profiller bulunduran özel izolasyon dolgulu kanat.
- + Kompozit alev almaz tip siyah kapı kolu ve paspartu kilit.
- + Çinko kaplamalı, yangın deformasyonuna dayanıklı, yatay ve dikey destekli menteşe (altta).
- + Kendiliğinden kapanma sağlayan yaylı ve pimli menteşe (üstte).
- + Kasanın 3 tarafına içten yerleştirilen, ısı karşısında şişerek izolasyon sağlayan, sıcak duman fitili.
- + Panik bar, hidrolik vb donanım montajı için güçlendirilmiş kanat yüzeyi.
- + EI 60 yangın kapılarında ortalama 35 kg/m² kanat ağırlığı.
- + EI 120 yangın kapılarında ortalama 45 kg/m² kanat ağırlığı.
- + Çift kanatlı kapılarda, ikinci kanatta alt üst kapama sürgüsü.
- + Çift kanatlı kapılarda, kanat sıralama mekanizması.
- + Çift kanatlı kapılarda, kanatların düzgün olarak birleşmesini sağlayan 2. kanat binisi.
- + Karton ambalaj.

Standart Ölçüler Standard Dimensions

Yükseklik Height (HVM)	Genişlik Width (LVM)
	800
	900
	1000
2050	1200
2150	1265
	1300
	1330
	1150 (800+350)
	1200 (800+400)
	1250 (800+450)
	1250 (900+350)
	1265 (665+600)
	1300 (900+400)
	1350 (900+450)
	1350 (1000+350)
2050	1400 (1000+400)
2150	1450 (1000+450)
	1500 (900+600)
	1600 (800+800)
	1700 (900+800)
	1800 (900+900)
	1800 (1000+800)
	1900 (1000+900)
	2000 (1000+1000)

- + EI 60 and EI 120 fire resistance certificate with UNI 9723 standard in compliance with the European Union norms.
- + Galvanized steel, anchored, heat-permeable thermal frame.
- + Special insulation filling leaf with "L" profiles in galvanized steel.
- + Composite non-flammable type black door handle and mat lock.
- + Zinc coated, fire deformation resistant, horizontal and vertical support hinge (bottom).
- + Spring and pin hinge ensuring automatic closure (top).
- + The hot smoke beads placed within the frame on 3 sides provide insulation by swelling during fire.
- + Leaf surface reinforced for fitting assembly such as panic bar and hydraulic etc.
- + Average 35 kg/m² leaf weight in REI 60 fire doors
- + Average 45 kg/m² leaf weight in REI 120 fire doors
- + Bottom-top locking bolt on second leaf of double leaf doors.
- + Leaf ordering mechanism in double leaf doors.
- + 2nd leaf interconnection ensuring seamless connection of the leaves in double leaf doors.
- + Carton packaging.

Opsiyonel Cam Uygulama Seçenekleri Optional glazing details

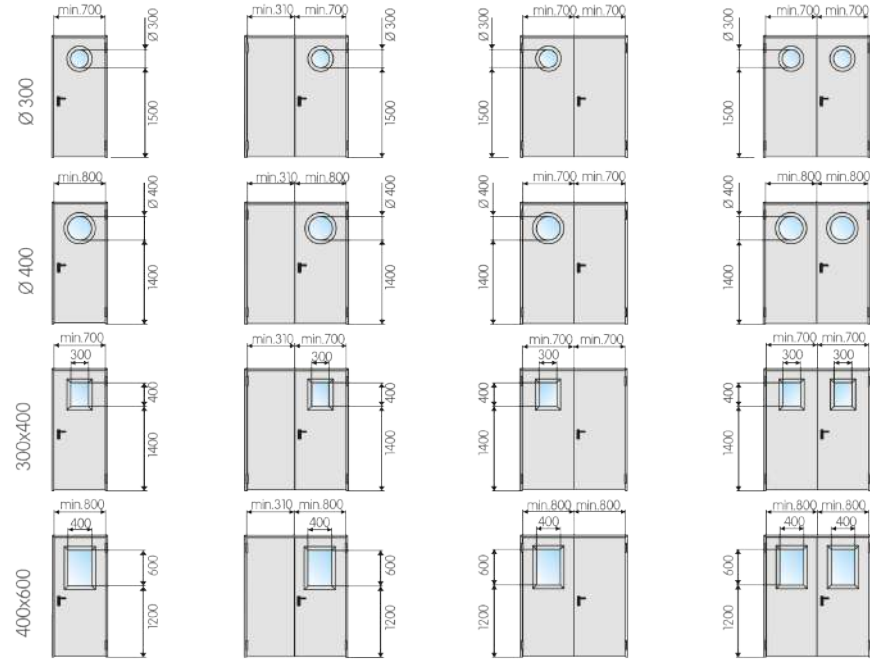

EI 60 / EI 120 EI 60 / EI 120

E: Alev ve duman geçişinin engellenmesi. / E: Prevention of flame and smoke passing.
I: Isı izolasyonu. / I: Heat insulation.

E tanımlaması ile mekanik kısımların dayanıklılığının yanı sıra alev ve dumanı bloke edebilen kapılar tanımlanır. EI tanımlaması ile alev ve duman blokesinin yanı sıra kapının soğuk tarafında maksimum 180 dereceye kadar ısıyı diğer yüze yansıtma özelliği belirtilmiş olur.

E defines the doors blocking the flame and smoke, in addition to the resistance of the mechanical parts. EI means non-reflection of heat up to maximum 180 degrees on the cold side of the door to the other side, in addition to blocking the flame and smoke.

Opsiyonel Özellikler Optional Specifications

- + Panik bar / + Panic bar
- + Barel / + Profile cylinder
- + Soğuk duman fitili / + Cold smoke bead
- + Yangın anında kanadı otomatik bırakan manyetik tutucu / + Magnetic holder automatically letting the leaf go in case of any fire
- + Hidrolik kapı kapatıcı / + Hydraulic door closer
- + Proje gereksinimine göre değişen ölçülerde yangın dayanımlı cam / + Fire resistant glass with different sizes according to the project requirement
- + Ses izolasyonu da sağlayan yangın dayanımlı giyotin süpürgelik ve eşik / + Fire rated door bottom mobile sill and threshold providing sound insulation
- + Merkezi otomasyon veya geçiş kontrol sistemlerine uyumlu donanım seçenekleri / + Fitting options compliant with central automation and passing control systems
- + İtme plakası, tekmelik vb. aksesuar uygulama imkânı / + Accessory installation alternatives such as pushing plate, toe board etc.

Kasa - Pervaz seçenekleri Frame - Architrave options

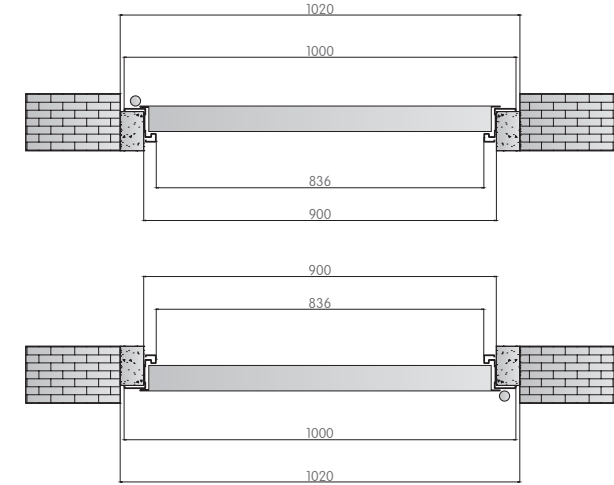

Yangın Kapısı Teknik Çizimi

Fire escape doors / EI 60 - EI 120

Encore Detaylar
Encore Details

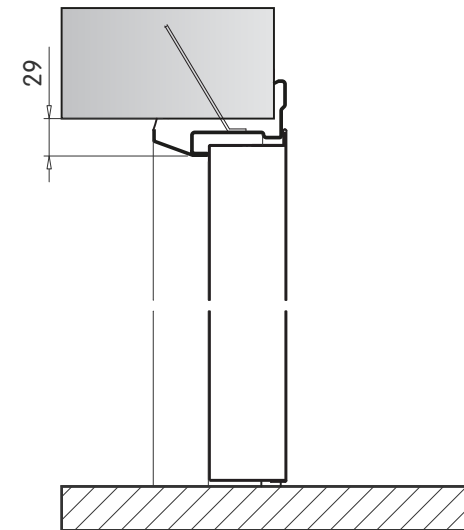
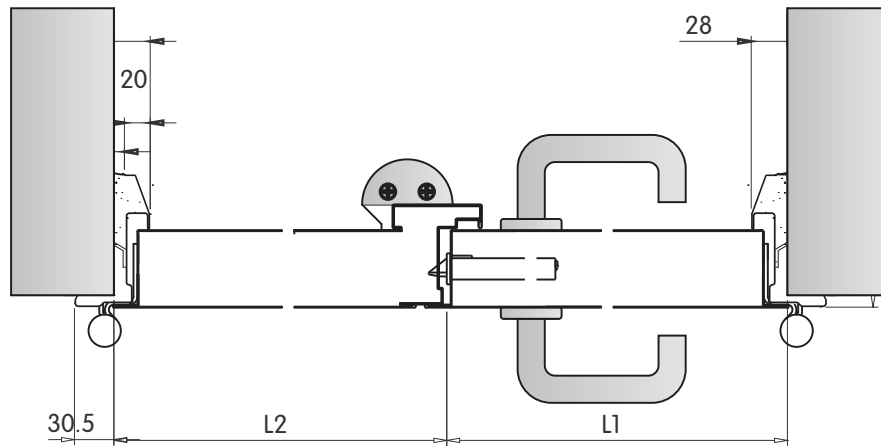
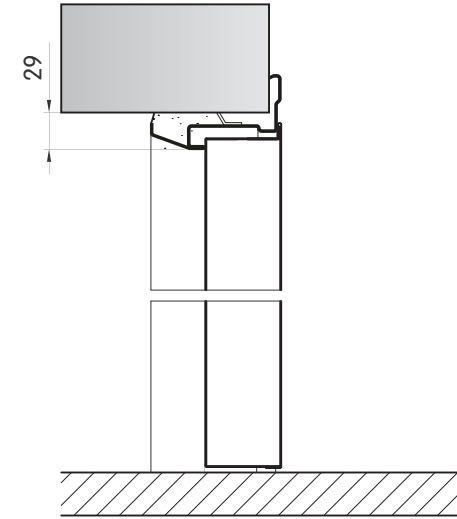
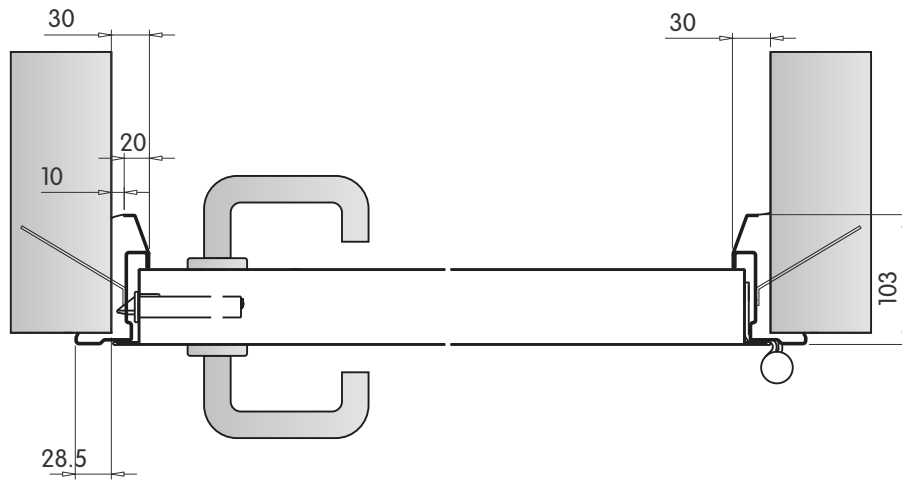

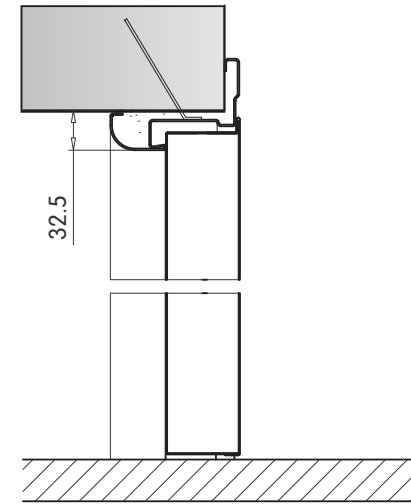
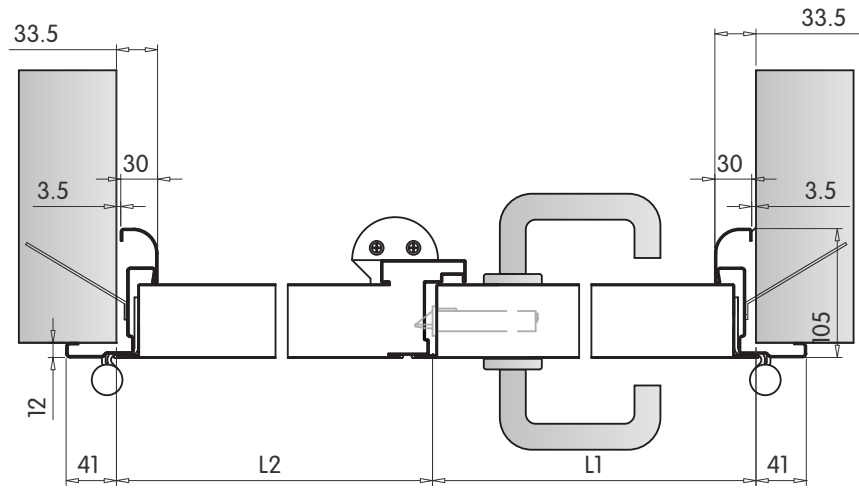
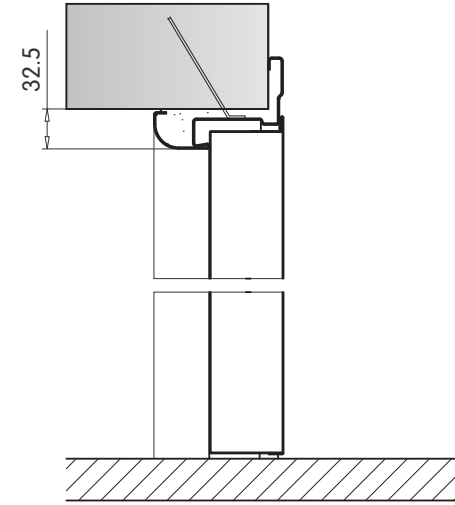
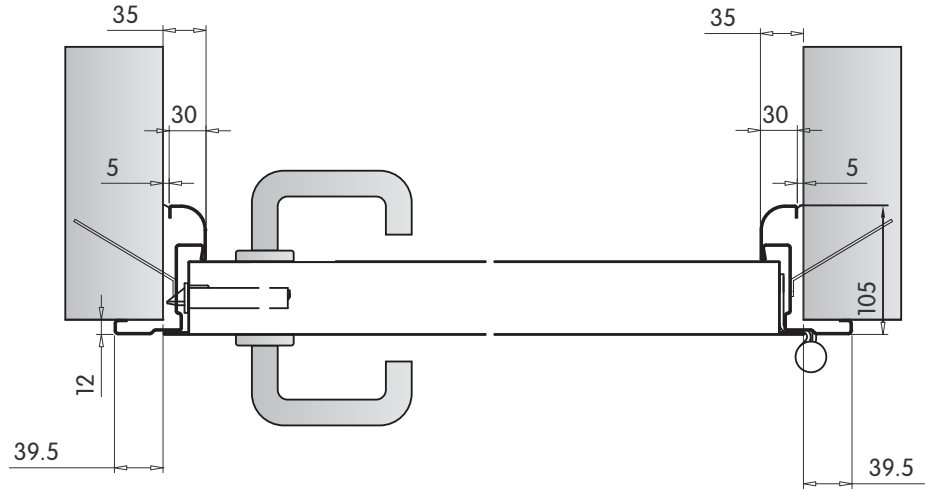

Yangın Kapısı Teknik Çizimi

Fire escape doors / EI 60 - EI 120

Endoor Detaylar Endoor Details

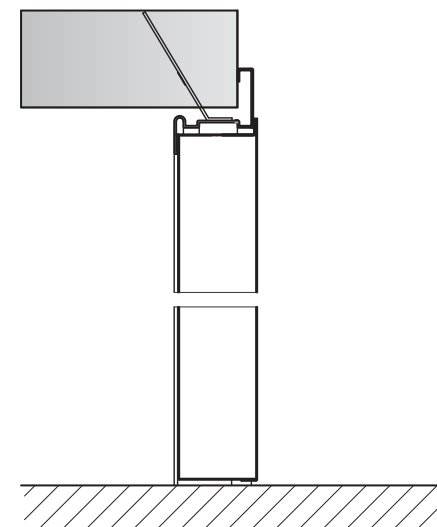
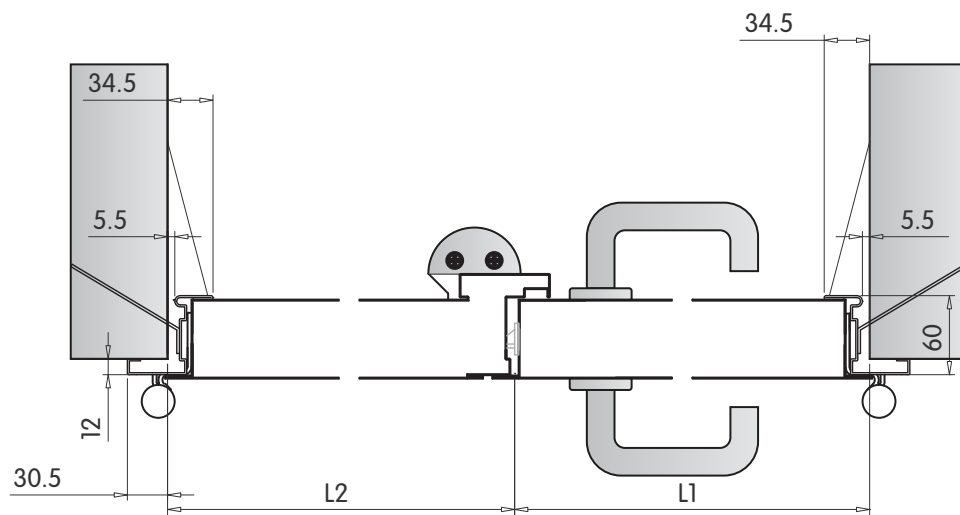
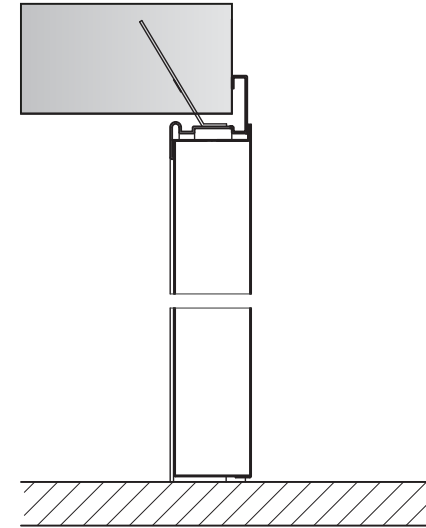
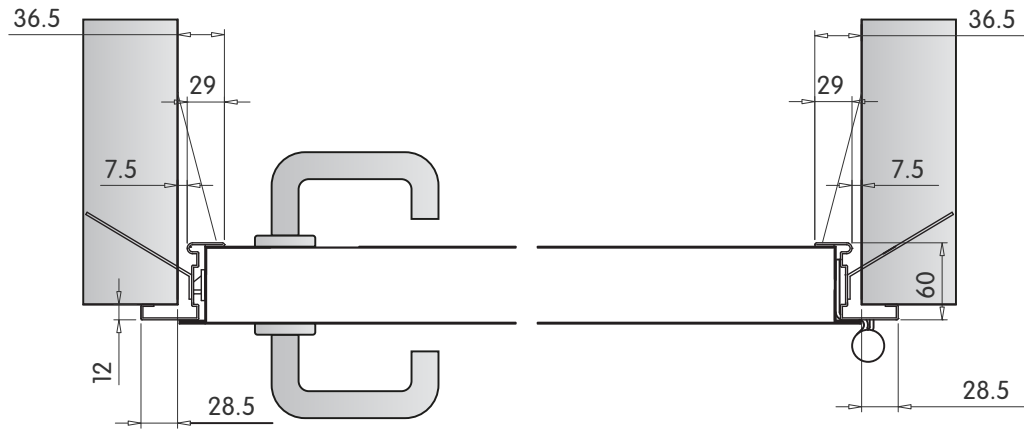

Standart Donanım Standard Hardware



Fıtil
Seal



Standart siyah kol
Standard black door
handle



Menteşe
Hinge

Uygulanabilir Renkler Available Styles

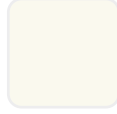

Fildişi
Ivory



Gri
Gray

Standart Ölçüler Standard Dimensions

Yükseklik Height (H/M)	Genişlik Width (L/M)
	800
	900
	1000
2050	1200
2150	1265
	1300
	1330
	1150 (800+350)
	1200 (800+400)
	1250 (800+450)
	1250 (900+350)
	1265 (665+600)
	1300 (900+400)
	1350 (900+450)
	1350 (1000+350)
2050	1400 (1000+400)
2150	1450 (1000+450)
	1500 (900+600)
	1600 (800+800)
	1700 (900+800)
	1800 (900+900)
	1800 (1000+800)
	1900 (1000+900)
	2000 (1000+1000)

Opsiyonel Donanım Optional Hardware



Panik bar
Panic bar



Panik bar
Panic bar



Hidrolik kapatıcı
Door closer

Farklı RAL renkleri opsiyonel olarak uygulanabilmektedir.
Standart dışı ölçüler opsiyonel olarak uygulanabilmektedir.

Different RAL colors are applied optionally.
Non-standard sizes are applied optionally.

Standart Özellikler Standard Specifications

- + Avrupa Birliği normlarına uygun, UNI 9723 standardında EI 60 ve EI 120 yangın dayanım sertifikası.
- + Galvanize çelik, ankrajlı, ısı geçirgen termik kasa.
- + Galvanize sac içinde "L" biçimli profiller bulunduran özel izolasyon dolgulu kanat.
- + Kompozit alev almaz tip siyah kapı kolu ve paspartu kilit.
- + Çinko kaplamalı, yangın deformasyonuna dayanıklı, yatay ve dikey destekli 3 adet menteşe.
- + Kasanın 3 tarafına içten yerleştirilen, ısı karşısında şişerek izolasyon sağlayan, sıcak duman fitili.
- + Panik bar, hidrolik vb donanım montajı için güçlendirilmiş kanat yüzeyi.
- + Çift kanatlı kapılarda, ikinci kanatta alt üst kapama sürgüsü.
- + Çift kanatlı kapılarda, kanat sıralama mekanizması.
- + Çift kanatlı kapılarda, kanatların düzgün olarak birleşmesini sağlayan 2. kanat binisi.

- + EI 60 and EI 120 fire resistance certificate with UNI 9723 standard in compliance with the European Union norms.
- + Galvanized steel, anchored, heat-permeable thermal frame.
- + Special insulation filling leaf with "L" profiles in galvanized steel.
- + Composite non-flammable type black door handle and mat lock.
- + Zinc coated, fire deformation resistant, horizontal and vertical support hinge (bottom).
- + Hot smoke seals placed within the frame on 3 sides providing insulation by swelling during fire.
- + Leaf surface reinforced for fitting assembly such as panic bar and hydraulic etc.
- + Bottom-top locking bolt on second leaf of double leaf doors.
- + Door coordinator in double leaf doors.
- + 2nd leaf rebate ensuring seamless connection of the leaves in double leaf doors.

Butik Uygulamalar / Special Applications

Jaluzili Kapılar
Jalousie doors

Deri Uygulama
Leather applications

Taç, Pervaz & Takoz Uygulamaları
Crown, architrave & batten applications

Jaluzi Kapı

Jalousie door

Modeller / Natura Royal Styles / Natura Royal

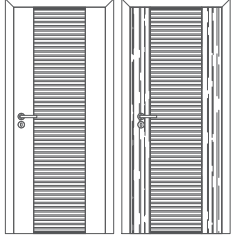

KL J01
FR J01
DV J01

NA J01
OL J01

Özellikler Features

Jaluzili kapı serisinde kanatlar 40 mm olarak üretilir ve L tipi aksesuar seti kullanılır. Jaluzi lamel renklerinde standart olarak 401 kodlu bej renk tercih edilir.

Uygulanabilen Jaluzi Renkler Available Jaluzi Colors



7130



Bej
Beige



642



Fildişi
Ivory



Pembe
Pink



Beyaz
White



Yeşil
Green



Gri
Gray



KL J01
Beyaz/White

Uygulanabilir Seriler Available Series

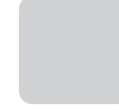

Kleon Line

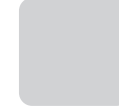

Organica

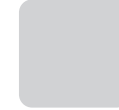

Natura

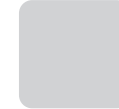

Divio Line

Modeller / Natura Royal Styles / Natura Royal

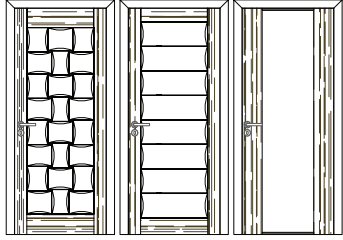

NA D01 NA D02 NA D03

Modeller / Organica Royal Styles / Organica Royal

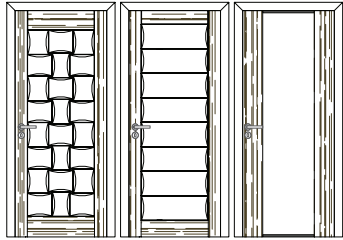

OR D01 OR D02 OR D03



OR D02
Amerikan Ceviz / Londra Koyu Kahve
American Walnut / London Dark Brown

Uygulanabilir Seriler Available Seires

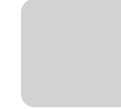

Natura

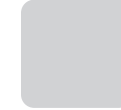

Organica

Uygulanabilir Deriler Available Styles



Londra krem
London cream



Çöl rüzgarı
Desert blow

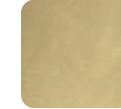

Newstar bej
Newstar belge



Londra koyu kahve
London dark brown

Süpürgelik & Takoz Uygulamaları

Skirting & Batten applications

Optima Plus motifleri ve renk alternatifleri ile hayal dünyanıza yeni kapılar açıyor.
Ahşap desenli





Süpürgelik & Takoz Uygulamaları

Skirting & Batten Applications

Uygulanabilir Modeller Available Styles



Özellikler Features

Jaluzili kapı serisinde kanatlar 40 mm olarak üretilir ve L tipi aksesuar seti kullanılır. Jaluzi lamel renklerinde standart olarak 401 kodlu bej renk tercih edilir.



KL 132
Fildişi / Ivory

Süpürgelik Skirting

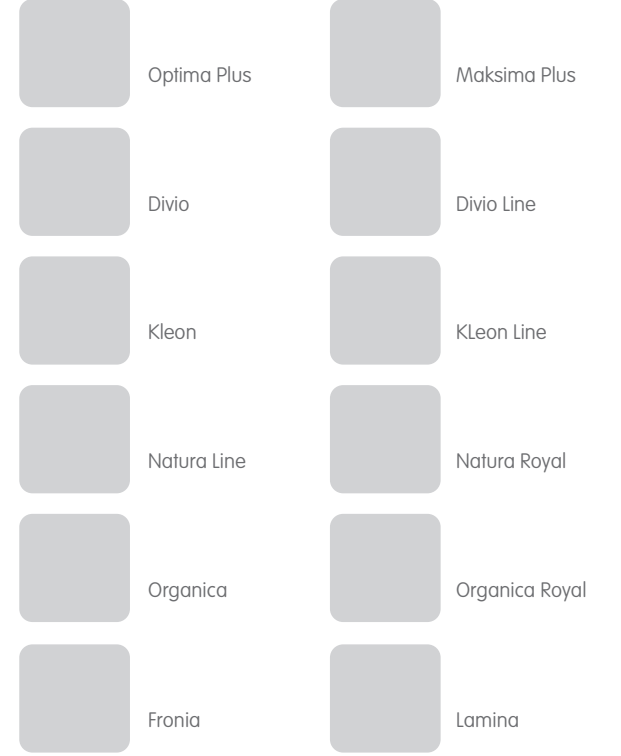

Takoz Available Styles

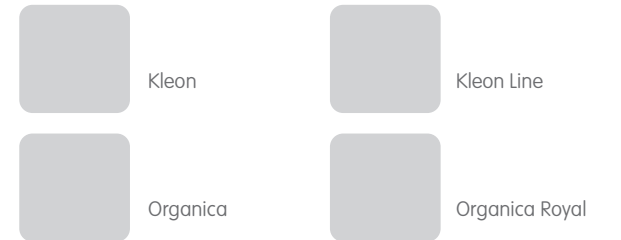

Süpürgelik Modelleri Available Styles

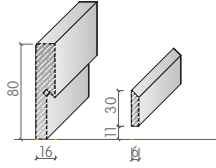

005
SÜPÜRGELİK
H:80mm
D:16mm
Aski Sistem

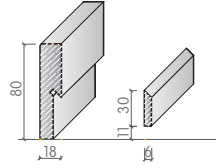

005
SÜPÜRGELİK
H:80mm
D:18mm
Aski Sistem

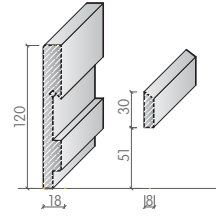

005
SÜPÜRGELİK
H:120mm
D:18mm
Aski Sistem

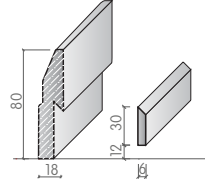

808
SÜPÜRGELİK
H:80mm
D:18mm
Aski Sistem

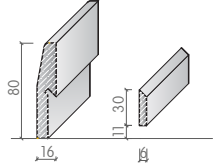

208
SÜPÜRGELİK
H:80mm
D:16mm
Aski Sistem

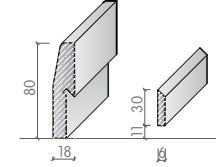

208
SÜPÜRGELİK
H:80mm
D:18mm
Aski Sistem

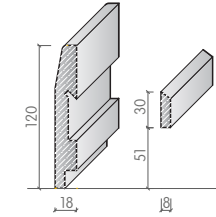

208
SÜPÜRGELİK
H:120mm
D:18mm
Aski Sistem

Takoz Modelleri Available Styles

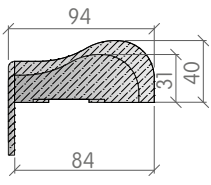

608 TAKOZ

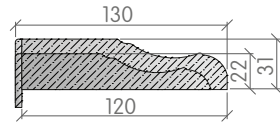

908 TAKOZ

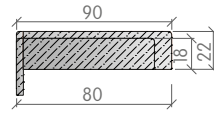

005 TAKOZ

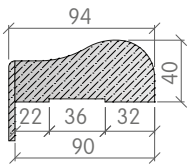
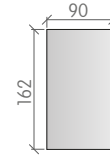
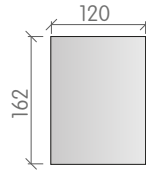
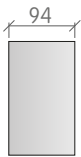

608 TAKOZ

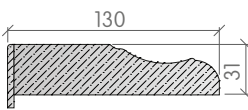

908 TAKOZ

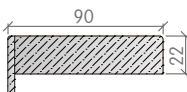

005 TAKOZ

Uygulanabilir Modeller Available Styles

708 TAÇ PERVAZ

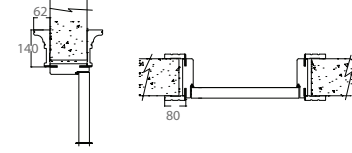
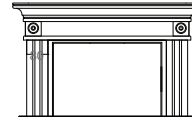

005 TAÇ PERVAZ

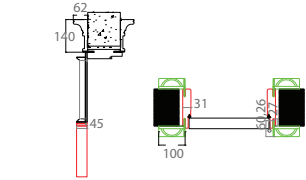
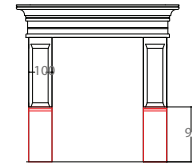

408 TAÇ PERVAZ

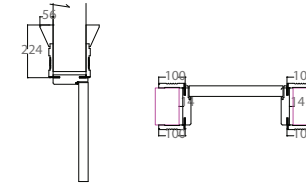
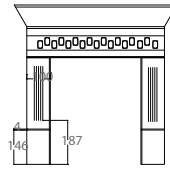

508 TAÇ PERVAZ

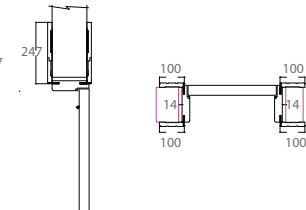
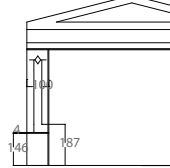

608 TAÇ PERVAZ

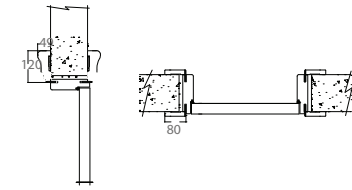
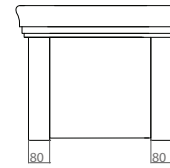

708 TAÇ PERVAZ

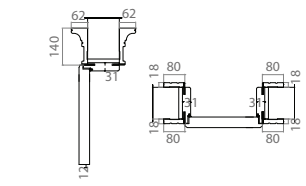
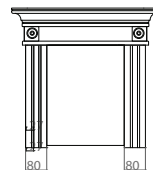

Açılım Seçenekleri / Door Opening Options

Sabit Bölmeli Kapı Uygulamaları
Fixed transom and side panels applications

Çarpma Kapılar
Double action swing doors

Katlanır Kapılar
Folding doors

İçten Sürgülü Kapılar
In-wall sliding doors

Dıştan Sürgülü Kapılar
Out-wall sliding doors

Sabit Bölmeli Kapı Uygulamaları

Fixed transom and side panels applications

Tek Kanat / Single Leaf

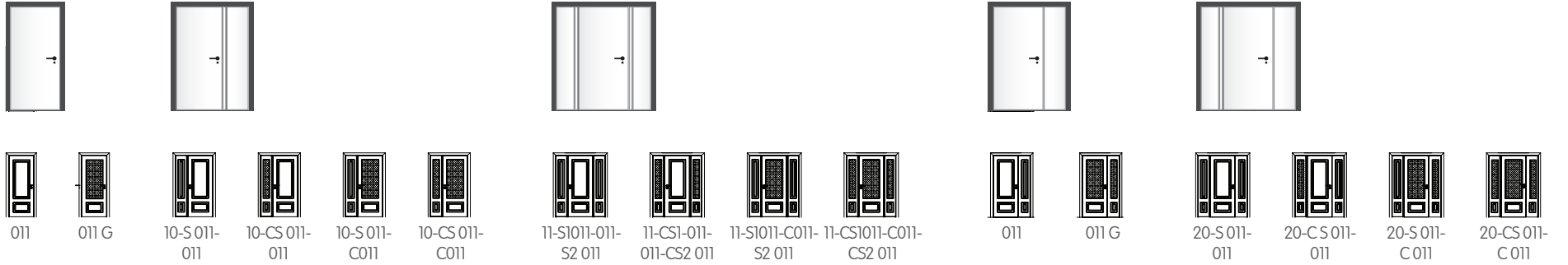

Tek Kanat / Single Leaf

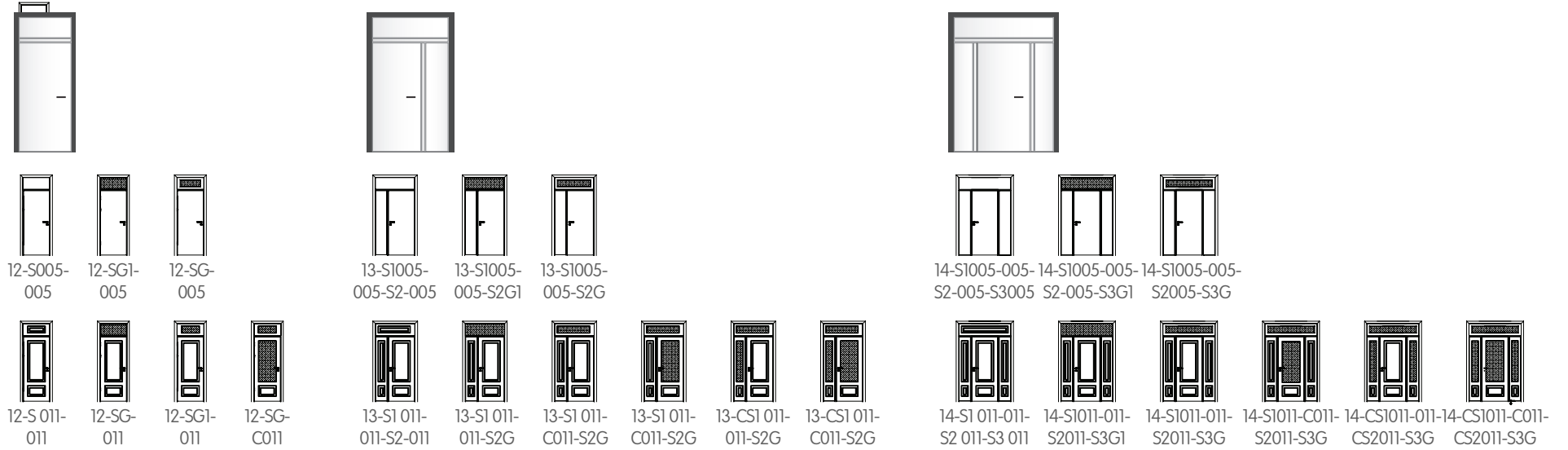

Tek Kanat / Single Leaf

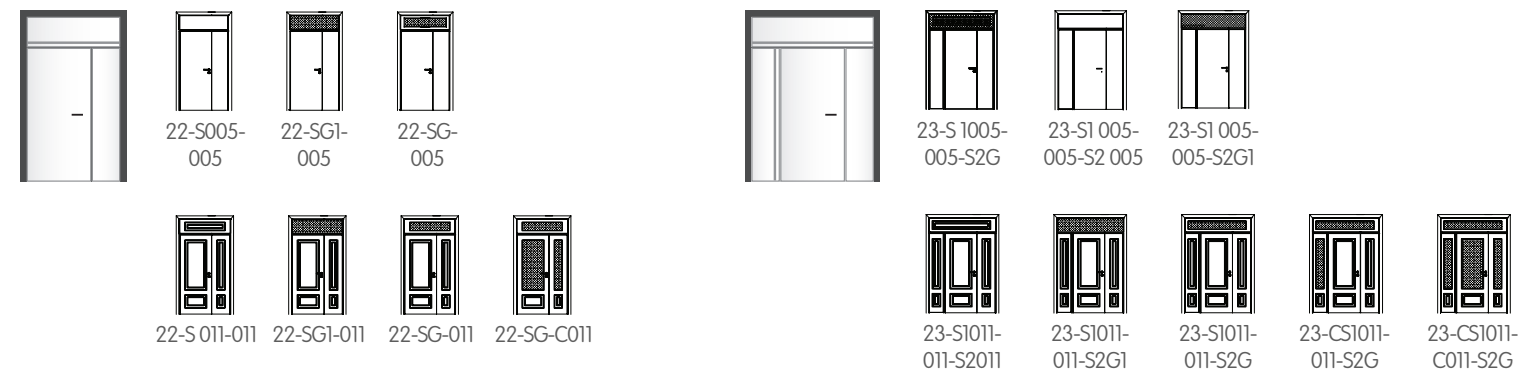

Çift Kanatlı / Double Leaf



011

011 G

30-S 011-011

30-CS 011-011

30-S 011-C011

30-CS 011-C011

31-S1 011-011 S011

31-CS1 011-011-011 CS2 011

31-S1 011-C011-S2 011

31-CS1 011-C011-CS2 011

Çift Kanatlı / Double Leaf

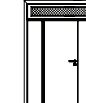
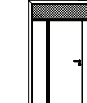
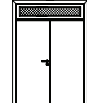
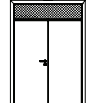
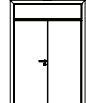
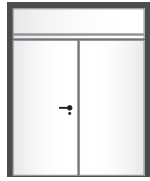

32-S 005-005

32-SG1 005-005

32-SG 005-005

33-S1 005-005-S2 005

33-S1 005-005-S2 G1

33-S1 005-005-S2 G

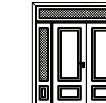
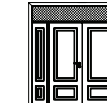
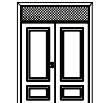

32-S 011-011

32-SG1-011

32-SG-011

32-SG-C011

33-S1011-011-S2011

33-S1011-011-S2G1

33-S1011-011-S3G

33-CS1011-011-S3G

33-CS1011-C011-S3G

Çift Kanatlı / Double Leaf

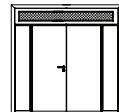
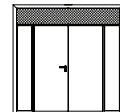
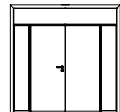

34-S1 005-005-S2 005-S3 005

34-S1 005-005-S2 005-S3 G1

34-S1 005-005-S2 005-S3 G

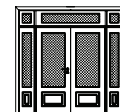
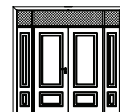

34-S1 011-011-S2 011-S3 005

34-S1 011-011-S2 011-S3G1

34-S1 011-S2 011-S3G

34-CS1 011-CS2 011-S3G

34-CS1 011-C011-CS2 011-S3G

Sabit Bölmeli Kapı Uygulamaları

Fixed transom and side panels applications

Tek Kanat / One Leaf



Yavru Kanatlı / Small Leaf



Çift Kanatlı / Double Leaf



Boşluk Aralığı	Sipariş Ölçüsü	Boşluk Aralığı	Sipariş Ölçüsü	Boşluk Aralığı	Sipariş Ölçüsü	Boşluk Aralığı	Sipariş Ölçüsü	Boşluk Aralığı	Sipariş Ölçüsü	Boşluk Aralığı	Sipariş Ölçüsü	Boşluk Aralığı	Sipariş Ölçüsü		
700	700	1200	800+400	1600	400+800+400	1200	800+400	1600	1200+400	1600	800+800	2000	1600+400	2300	400+1500+400
750	750	1300	900+400	1700	400+900+400	1300	900+400	1700	1300+400	1700	850+850	2100	1700+400	2400	400+1600+400
800	800	1400	950+450	1800	400+1000+400	1400	950+450	1800	1400+400	1800	900+900	2200	1800+400	2500	400+1700+400
850	850	1500	1000+500	1900	450+1000+450	1500	1000+500	1900	1500+400	1900	950+950	2300	1900+400	2600	400+1800+400
900	900			2000	500+1000+500			2000	1500+500	2000	1000+1000	2400	2000+400	2700	400+1900+400
												2500	2000+500	2800	400+2000+400
												2600	2000+600	2900	450+2000+450
														3000	500+2000+500

Boşluk Aralığı	Sipariş Ölçüsü	Boşluk Aralığı	Sipariş Ölçüsü	Boşluk Aralığı	Sipariş Ölçüsü	Boşluk Aralığı	Sipariş Ölçüsü	Boşluk Aralığı	Sipariş Ölçüsü	Boşluk Aralığı	Sipariş Ölçüsü	Boşluk Aralığı	Sipariş Ölçüsü
2400	2100+300	2400	2100+300	2400	2100+300	2400	2100+300	2400	2100+300	2400	2100+300	2400	2100+300
2500	2100+400	2500	2100+400	2500	2100+400	2500	2100+400	2500	2100+400	2500	2100+400	2500	2100+400
2600	2100+500	2600	2100+500	2600	2100+500	2600	2100+500	2600	2100+500	2600	2100+500	2600	2100+500
2700	2200+500	2700	2200+500	2700	2200+500	2700	2200+500	2700	2200+500	2700	2200+500	2700	2200+500
2800	2200+600	2800	2200+600	2800	2200+600	2800	2200+600	2800	2200+600	2800	2200+600	2800	2200+600
2900	2300+600	2900	2300+600	2900	2300+600	2900	2300+600	2900	2300+600	2900	2300+600	2900	2300+600
3000	2300+700	3000	2300+700	3000	2300+700	3000	2300+700	3000	2300+700	3000	2300+700	3000	2300+700

Tek Kanat / One Leaf

Yavru Kanatlı / Small Leaf

Çift Kanatlı / Double Leaf



Boşluk Aralığı	Sipariş Ölçüsü	Boşluk Aralığı	Sipariş Ölçüsü	Boşluk Aralığı	Sipariş Ölçüsü	Boşluk Aralığı	Sipariş Ölçüsü	Boşluk Aralığı	Sipariş Ölçüsü	Boşluk Aralığı	Sipariş Ölçüsü	Boşluk Aralığı	Sipariş Ölçüsü		
70	70	1200	800+400	1600	400+800+400	1200	800+400	1600	1200+400	1600	800+800	2000	1600+400	2300	400+1500+400
75	75	1300	900+400	1700	400+900+400	1300	900+400	1700	1300+400	1700	850+850	2100	1700+400	2400	400+1600+400
80	80	1400	950+450	1800	400+1000+400	1400	950+450	1800	1400+400	1800	900+900	2200	1800+400	2500	400+1700+400
85	85	1500	1000+500	1900	450+1000+450	1500	1000+500	1900	1500+400	1900	950+950	2300	1900+400	2600	400+1800+400
90	90			2000	500+1000+500			2000	1500+500	2000	1000+1000	2400	2000+400	2700	400+1900+400
												2500	2000+500	2800	400+2000+400
												2600	2000+600	2900	450+2000+450
														3000	500+2000+500

Çarpma Kapı

Swing Door

Modeller Styles

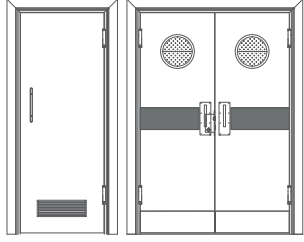

NA 005

CL 005 G2

Kasa - Pervaz seçenekleri Frame - Architrave options

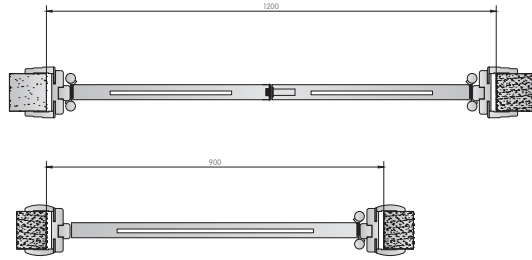

Opsiyonel Donanım Optional Hardware

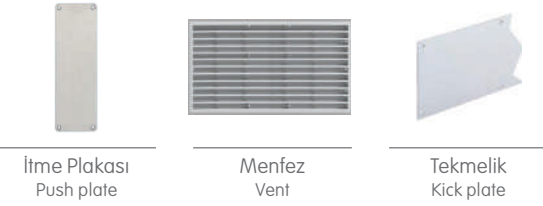

İtme Plakası
Push plate

Menfez
Vent

Tekmelik
Kick plate

Standart Donanım Standard Hardware

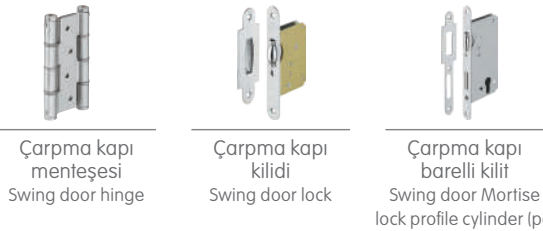

Çarpma kapı
menteşesi
Swing door hinge

Çarpma kapı
kilidi
Swing door lock

Çarpma kapı
barelli kilit
Swing door Mortise
lock profile cylinder (pc)



Çekme kollu
itme plakası
Push plate with handle



NA 005
Meşe / Oak

Uygulanabilir Seriler Available Styles



Öneriler Suggestions

*Çarpma kapılarda kanat kalınlığı 40 mm olarak üretilir. Özel çarpma menteşesi ve kilidi ile sunulur. Opsiyonel olarak barelli çarpma kilit seçeneği de bulunmaktadır. İlgili ürün platformlarındaki modellerden aşağıda belirtilenler dışındaki tümü.

For the swing doors, the leaf is manufactured with 40 mm thickness. They are supplied with special swing hinge and lock with roller latch. Mortise lock for cylinder is also optionally available.

Donanım Renk Seçenekleri Hardware Color Alternatives



Katlanır Kapı

Folding door

Modeller / Natura Royal Styles / Natura Royal

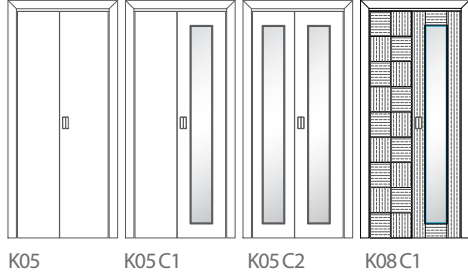

Kasa - Pervaz seçenekleri Frame - Architrave options

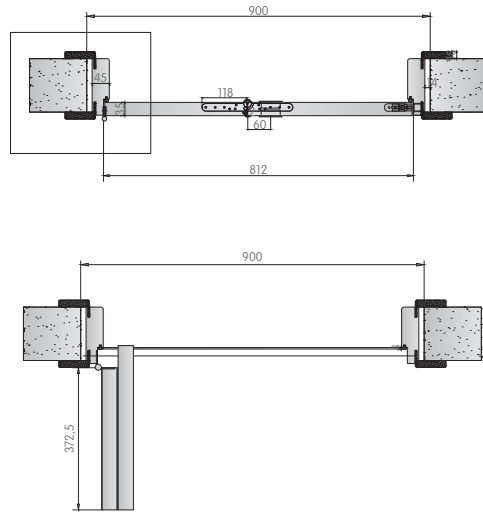

MP K05
Beyaz / White

Uygulanabilir Seriler Available Seris



Öneriler Sugestions

* Katlanır kapılarda kanatlar 35 mm kalınlığında ve kiltsiz olarak üretilir. Krom renğinde özel aksesuar seti ile sunulur.

For the folding doors, the leaf is manufactured with 35 mm thickness and without lock. They are supplied with chrome colored special hardware set.

İçten Sürgülü Kapılar

In-Wall Sliding Doors

Performans Uygulamaları Performance Applications

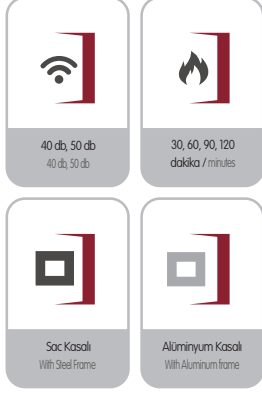

Kullanım Alanları Area of use

Rezidans / Residence

Daire Giriş Kapısı
Imperium plus flat entrance door

Villa Giriş Kapısı
Villa entrance door

Öneriler Suggestions

- 1- DIVIO TÜM MODELLER(540-541-550-551 HARIÇ)
- 2- KLEON TÜM MODELLER (KL 400-CK600-13A-13L HARIÇ)
- 3- FRONIA TÜM MODELLER (FR 571-FR 570 HARIÇ)
- 4- NATURA ROYAL TÜM MODELLER(E02-E03-E04-D01-D02-D03-
- 5-NA J01 MODELLERİ HARIÇ) UYGULANIR.
- 6- ORGANICA LINE 005 ÇITASIZ , DERZLİ VE 105 CAMLI MODELLERİ
- 7- ORGANICA ROYAL 005 ÇITASIZ MODEL UYGULANIR.

Kanat kalınlığı 40 mm olarak uygulanabilmektedir.
The leaf thickness applied on sliding doors is 40 mm.

Uygulanabilir Seriler Available Series



Sistemler Systems

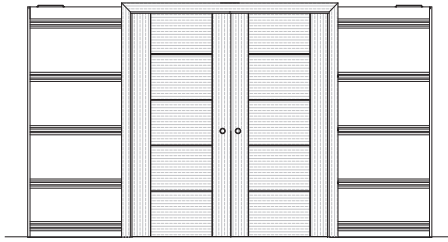
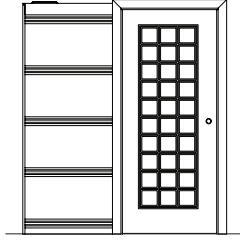

Kasa - Pervaz seçenekleri Frame - Architrave options

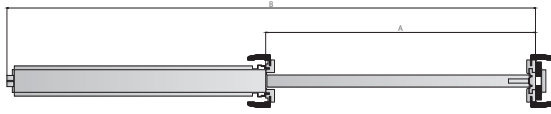

Pervaz Birleşim Seçenekleri Architrave Joints Options

■ 45°

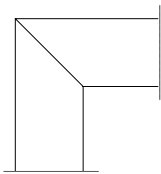

Birleşim Standart
Combination Standard

■ 90°

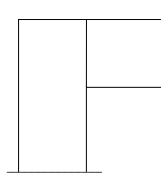

Birleşim Opsiyonel
Combination Optional

Standart ölçüler Standard dimensions

Genişlik / Width (mm)

A B

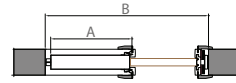

Tek kanat İçten Sürme
In-wall sliding door
single leaf



800	1710
900	1910
1000	2110

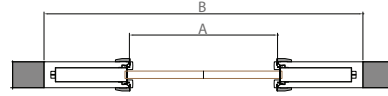

Çift kanat İçten Sürme
In-wall sliding door
double leaf



1600	3322
1800	3722
2000	4122

Yükseklik / Height (mm)

E F

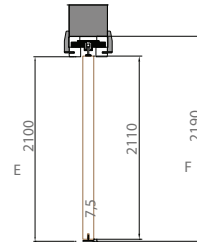

Tek kanat İçten Sürme
In-wall sliding door
single leaf



Çift kanat İçten Sürme
In-wall sliding door
double leaf

2100	2185
------	------

Duvar Kalınlığı / Wall thickness (mm)

D D'

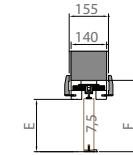

Tek kanat İçten Sürme
In-wall sliding door
single leaf



Çift kanat İçten Sürme
In-wall sliding door
double leaf

140	135
-----	-----

Min-maks ölçüler Min-max dimensions

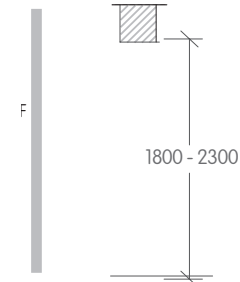
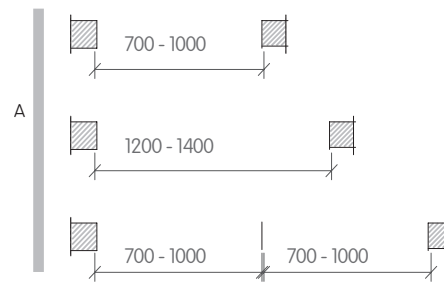

Dıştan Sürgülü Kapılar

Out-Wall Sliding Doors

Performans Uygulamaları Performance Applications

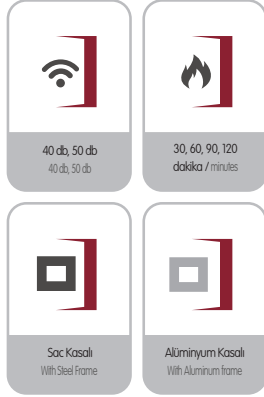

Kullanım Alanları Area of use

Rezidans / Residence

Daire Giriş Kapısı
Imperium plus flat entrance door

Villa Giriş Kapısı
Villa entrance door

Öneriler Suggestions

- 1- NA J01 MODELLERİ HARİÇ) UYGULANIR.
- 2- ORGANICA LINE 005 ÇİTASIZ , DERZLİ VE 105 CAMLI MODELLERİ
- 3- ORGANICA ROYAL 005 ÇİTASIZ MODEL UYGULANIR.

Kanat kalınlığı 40 mm olarak uygulanabilmektedir.
The leaf thickness applied on sliding doors is 40 mm.



Uygulanabilir Seriler Available Series



Sistemler Systems

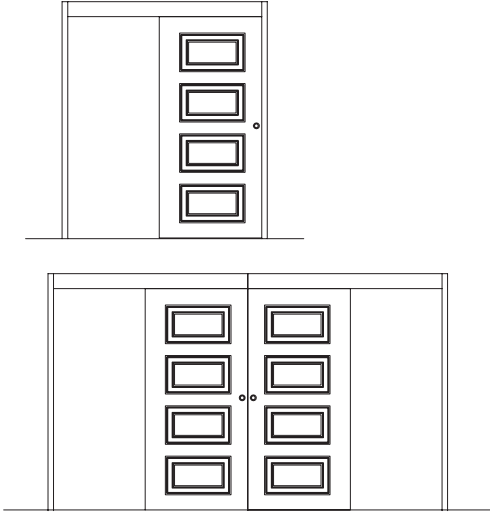

Kasa - Pervaz seçenekleri Frame - Architrave options

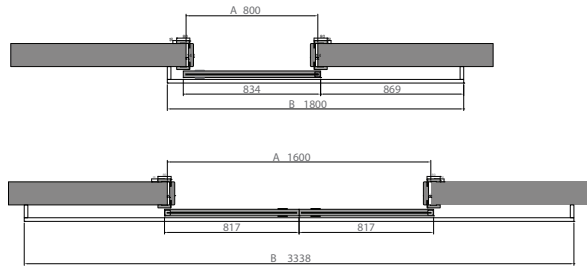

Pervaz Birleşim Seçenekleri Architrave Joints Options

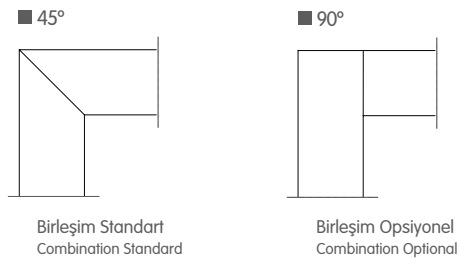

Standart ölçüler Standard dimensions

Genişlik / Width (mm)		A	B	
	Tek kanat Dıştan Sürme Out-wall sliding door single leaf	800	1954	
		900	2154	
	Çift kanat Dıştan Sürme Out-wall sliding door double leaf	1600	3446	
		1800	3846	
Yükseklik / Height (mm)		E	F	
	Tek kanat Dıştan Sürme Out-wall sliding door single leaf	2100	2220	
	Çift kanat Dıştan Sürme Out-wall sliding door double leaf			
Duvar Kalınlığı / Wall thickness (mm)		G	D	D'
	Tek kanat Dıştan Sürme Out-wall sliding door single leaf	100	100	115
	Çift kanat Dıştan Sürme Out-wall sliding door double leaf	100	120	135
		100	140	155
		100	160	175
		100	180	195
		100	200	215

Min-maks ölçüler Min-max dimensions

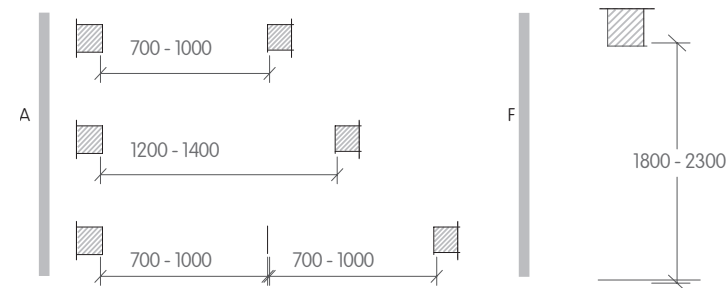

Ahşap Daire Giriş Kapıları / Wooden Flat Entrance Doors

Imperium Plus

İmperium Plus

İmperium Plus iç kapılarda hissedilen ahşabın sıcaklığını, çelik kapıların yüksek güvenlik donanımlarıyla birleştiriyor.

İmperium Plus assembles the warmth of the wood felt in the interior doors with the high safety of the steel doors.





İmperium Plus

Performans Uygulamaları Performance Applications



Kullanım Alanları Area of use

Otel / Hotel

İmperium Plus Daire Giriş Kapısı
İmperium Plus Flat Entrance Door

Sparta 8 Çelik Kapı Giydirme Uygulaması
Sp 8 steel door wood panel applications

SP9 & SENTRY 4 Çelik Kapı Giydirme Uygulaması
SP9 & SENTRY 4 Steel Door Wood Panel Applications

Öneriler Suggestions

*İmperim Plus serisi kapılar daire giriş noktaları ve rezidanslarda kullanılması için özel olarak tasarlanmış giriş kapıdır. Dış hava koşullarına direkt olarak maruz kalınan villa girişi vb. noktalarda kullanılması kesinlikle önerilmemektedir. Bu noktalar için İmperium Masif serisi kapılar önerilmektedir.

İmperium Plus series doors are specially designed for residences and flat entrances. It is not recommended to use İmperium Plus series doors in places exposed directly to weather conditions such as villa entrances etc. For such locations it is recommended to use İmperium solid wood exterior doors.



IMP KL 310
Beyaz / White

Uygulanabilir Seriler Available Seris



Standart Donanım Standard Hardware



Uygulanabilir Modeller Styles

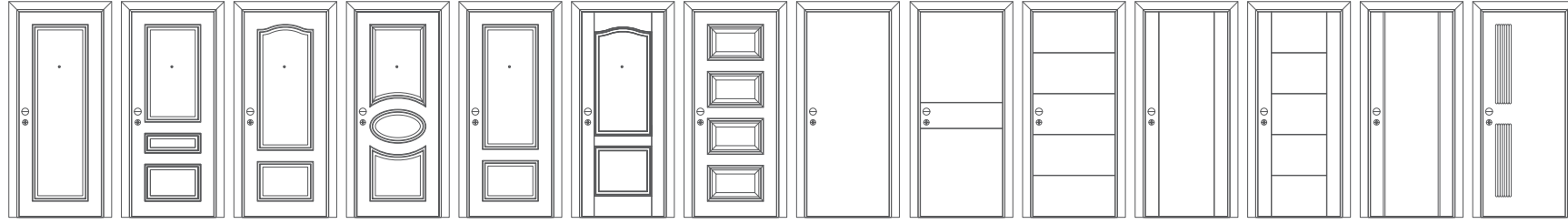

IP PO 133 IP PO 093 IP PO 084 IP PO 063 IP PO 013 IP PO 082 IP PO 023 IP PO 005 IP PO 5F1 IP PO 5F2 IP PO 5F3 IP PO 7F2 IP PO 006 IP PO 192
IP DV 005 IP DV 5F1 IP DV 5F2 IP DV 5F3
IP KL 005 IP KL 9F1 IP KL 9F2 IP KL 9F3

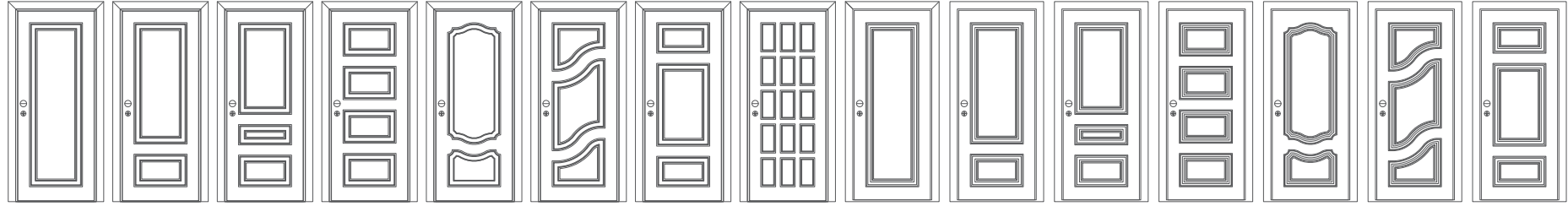

IP DV 131 IP DV 011 IP DV 091 IP DV 021 IP DV 051 IP DV 071 IP DV 151 IP DV 350 IP KL 132 IP KL 012 IP KL 092 IP KL 022 IP KL 052 IP KL 072 IP KL 152

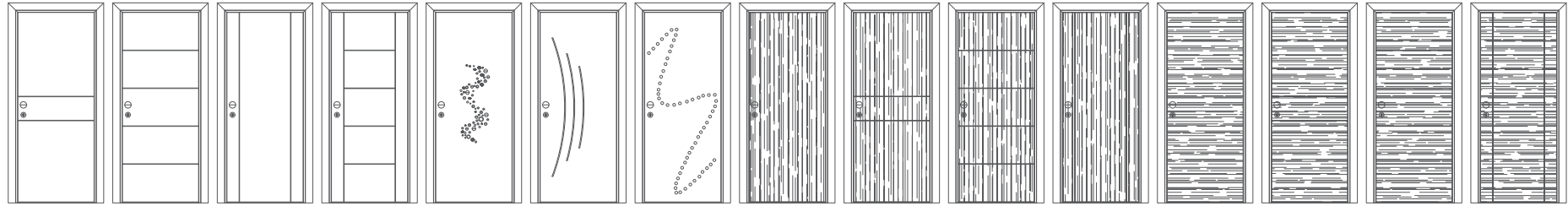

IP KL 5W1 IP KL 5W2 IP KL 5W3 IP KL 7W2 IP KW 601 IP KW 602 IP KW 603 IP NA 005 IP NA 5F1 IP NA 5F2 IP NA 5F3 IP NA 006 IP NA 6F1 IP NA 6F2 IP NA 6F3
IP OL 005 IP OL 5F1 IP OL 5F2 IP OL 5F3 IP OL 006 IP OL 6F1 IP OL 6F2 IP OL 6F3

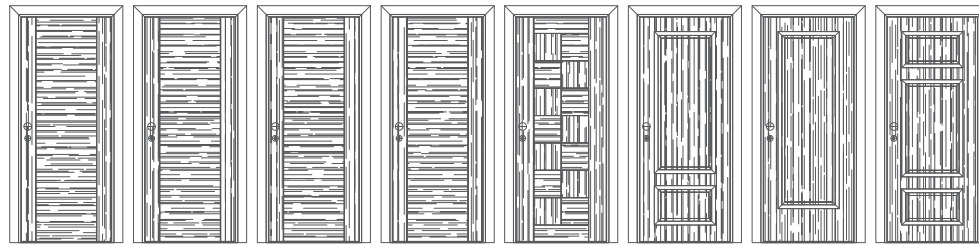

IP NA 007 IP NA 7F1 IP NA 7F2 IP NA 7F3 IP NA 008 IP OL 015 IP OL 135 IP OL 155
IP OL 007 IP OL 7F1 IP OL 7F2 IP OL 7F3 IP OL 008

Kasa - Pervaz seçenekleri Frame - Architrave options

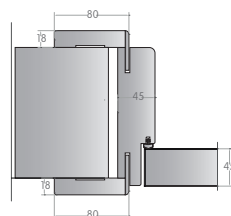
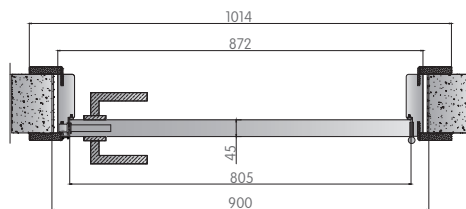

Donanım Renk Seçenekleri Hardware Color Alternatives

- Paslanmaz Çelik
Stainless Steel
- Parlak Krom
Chrome Polished
- Mat Krom
Chrome Matt
- Pırnç
Brass

İç Kapı Tamamlayıcı Detaylar / Interior Doors Complementary

Opsiyonel Aksesuarlar
Optional accessories

Master Anahtar Çözümleri
Master key solutions

Opsiyonel Aksesuarlar

Optional Accessories



Özel kapı kolları Special door handles



Meroni Pigio



Meroni Nova

Uygulanabilir Modeller
Styles

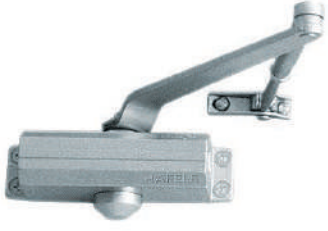

Dirsek kollu kapı kapatıcı

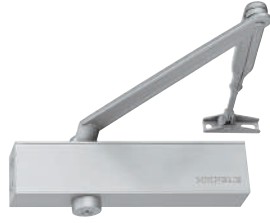

Dirsek kollu kapı kapatıcı



Kayar kanallı kapı kapatıcı



Gizli kapı kapatıcı



Zemine gömme kapı kapatıcı

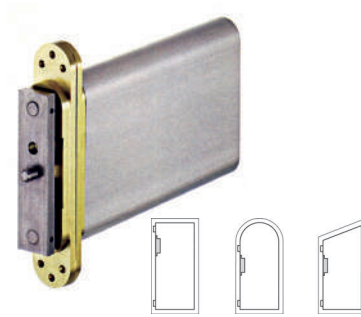

Özel kapı kapatıcı / Special door closer

Özel kapı stoperleri
Special door buffers



Vidalı



Kendinden yapışkanlı
Self-adhesive



Kapı dübünleri
Inspection hale

Master Anahtar Çözümleri

Master key solutions

GMK-Sistem (Genel Master Anahtar Sistemi) GMK-System (General Master Key System)

Ana master anahtar, sistem yöneticilerinin sistemde mevcut bulunan bütün kapıları açmalarına olanak sağlar ve bu sırada diğer kullanıcılara sadece belirli kapıları açan anahtarlar sunulur. Dolayısıyla, kilitleme sistemi farklı seviyelerde yetkilere göre düzenlenmiştir. The grand master key enables system managers to open every door in the system – while other users are provided with keys that only open specific doors. Therefore, the locking system is divided into various levels of authorization.

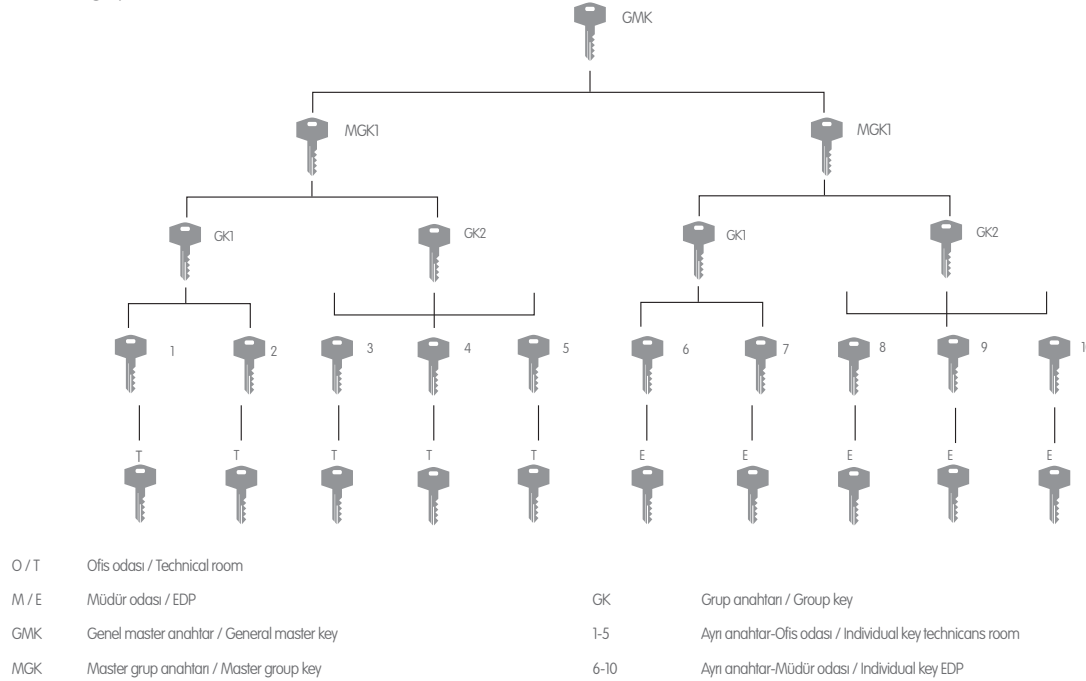

Kapı veya oda Door or room name	Barel ve anahtar no. Cyl. and Key no.	Barel sayısı Number of cylinders	Ürün no. Cat. No.	A Ölçüsü Length A	B Ölçüsü Length B	Anahtar sayısı Number of keys	Uygulama alanı / Area of operation	Anahtar no. / Key no.
Ofis odası 1 Technical room 1	1	1	91.....	27.5 mm	27.5 mm	3	Yönelim-Yangın bölüğü Managing Director / Fire brigade	GMK
Ofis odası 2 Technical room 2	2	1	91.....	27.5 mm	27.5 mm	3	Ofis yöneticisi Departmental manager technology	MGK1
Ofis odası 3 Technical room 3	3	1	91.....	27.5 mm	27.5 mm	3	Departman müdürü M Departmental manager EDP	MGK2
Ofis odası 4 Technical room 4	4	1	91.....	27.5 mm	27.5 mm	3	Müdür Office manager technology	GK1
Ofis odası 5 Technical room 5	5	1	91.....	27.5 mm	27.5 mm	3	Satış müdürü Sales department technology	GK2
Müdür odası 6 EDP 6	6	1	91.....	27.5 mm	27.5 mm	3	Müdür M Office manager EDP	GK3
Müdür odası 7 EDP 7	7	1	91.....	27.5 mm	27.5 mm	3	Satış departmanı M Sales department EDP	GK4
Müdür odası 8 EDP 8	8	1	91.....	27.5 mm	27.5 mm	3		
Müdür odası 9 EDP 9	9	1	91.....	27.5 mm	27.5 mm	3		
Müdür odası 10 EDP 10	10	1	91.....	27.5 mm	27.5 mm	3		

CL-Sistem (Merkezi kilit sistemi)

CL-System (Central lock system)

Bu sistemde her kullanıcı kendine verilen merkezi anahtarla sıkça kullandığı ana kapının merkezi barelini ve sadece kendi kapısını açabilir.

With this system each user can lock the central cylinder of commonly used main door and only his door cylinder with his superior key.

A / A	Apartman daire giriş kapısı / Apartment front door
OK / F	Ön kapı / Front door
C / C	*C*barelini kilitleyen merkez anahtar / Central key, which locks the central cylinder C
1-4	Apartman daireleri için yetkili anahtar / Superior keys for apartment front doors

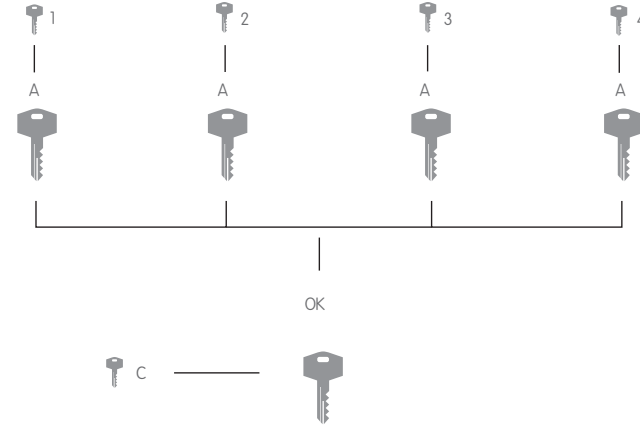

Kapı veya oda Door or room name	Barel ve anahtar no. Cyl. and Key no.	Barel sayısı Number of cylinders	Ürün no. Cat. No.	A Ölçüsü Length A	B Ölçüsü Length B	Anahtar sayısı Number of keys						
Ön kapı Font door	C	1	91.....	27.5 mm	27.5 mm	3		X	X	X	X	X
Daire 1 Apartment 1	1	1	91.....	27.5 mm	27.5 mm	3			X			
Daire 2 Apartment 2	2	1	91.....	27.5 mm	27.5 mm	3				X		
Daire 3 Apartment 3	3	1	91.....	27.5 mm	27.5 mm	3					X	
Daire 4 Apartment 4	4	1	91.....	27.5 mm	27.5 mm	3						X

MK-Sistem (Master Anahtar Sistemi)

MK-System (Master Key System)

Ev ve ofis kullanıcıları için farklı kilit silindirleri bir tek master anahtar ile kontrol edilebilir. Bütün bareller kendi anahtarları ile açılabilir gibi master anahtar ile de açılabilir.

Different locking cylinders for home, office users cylinders may be incorporated into a single master key system, controlled by one key. Each locking cylinder can be locked with the master key as well as with the individual key allocated to it.

D / S	Depo odası / Store room
MK / MK	Master anahtar / Master key
1-4	Aynı anahtar / Individual key store rooms

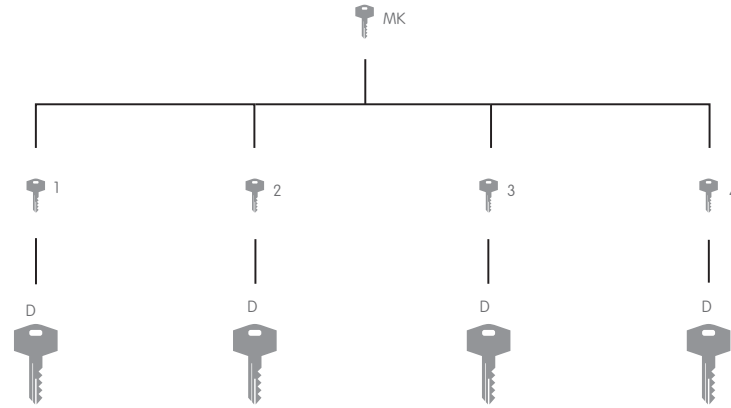

Kapı veya oda Door or room name	Barel ve anahtar no. Cyl. and Key no.	Barel sayısı Number of cylinders	Ürün no. Cat. No.	A Ölçüsü Length A	B Ölçüsü Length B	Anahtar sayısı Number of keys						
Depo odası 1 Store 1	1	1	91.....	27.5 mm	27.5 mm	3						
Depo odası 2 Store 2	2	1	91.....	27.5 mm	27.5 mm	3						
Depo odası 3 Store 3	3	1	91.....	27.5 mm	27.5 mm	3						
Depo odası 4 Store 4	4	1	91.....	27.5 mm	27.5 mm	3						

Çelik Kapı / Steel Security Doors

Sparta 8

Sparta 9

Wall Security

Sparta 8

Sparta 8 DorteK yüksek güvenlik bareli ve kopyalanamaz anahtar sistemi ile güvenlik anlayışında yeni bir çağ açıyor.

Sparta 8 opens a new era of security with DorteK high security cylinder and non-copyable key systems.





15

6

Performans Uygulamaları Performance Applications



Kullanım Alanları Area of use

Otel / Hotel
Sparta 8 Daire Giriş Kapısı
Sparta 8 plus flat entrance door

Sparta 8 Çelik Kapı Giydirme Uygulaması
Sp 8 steel door wood panel applications

Çelik Kapı Giydirme Uygulaması
Steel door wood panel applications

* Düz ve Fugalı modellerde 6mm giydirme,
diğer tüm modellerde 14mm giydirme
uygulanacaktır.



OP 5F2
İtalyan Ceviz / Italian Walnut

Uygulanabilir Seriler Available Seriler

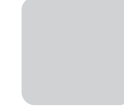

Kleon

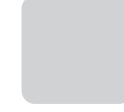

Divio

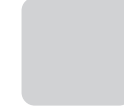

Optima plus

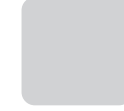

Natura

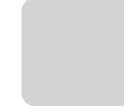

Organica

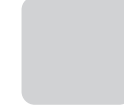

Fronia

Uygulanabilir Modeller
Styles

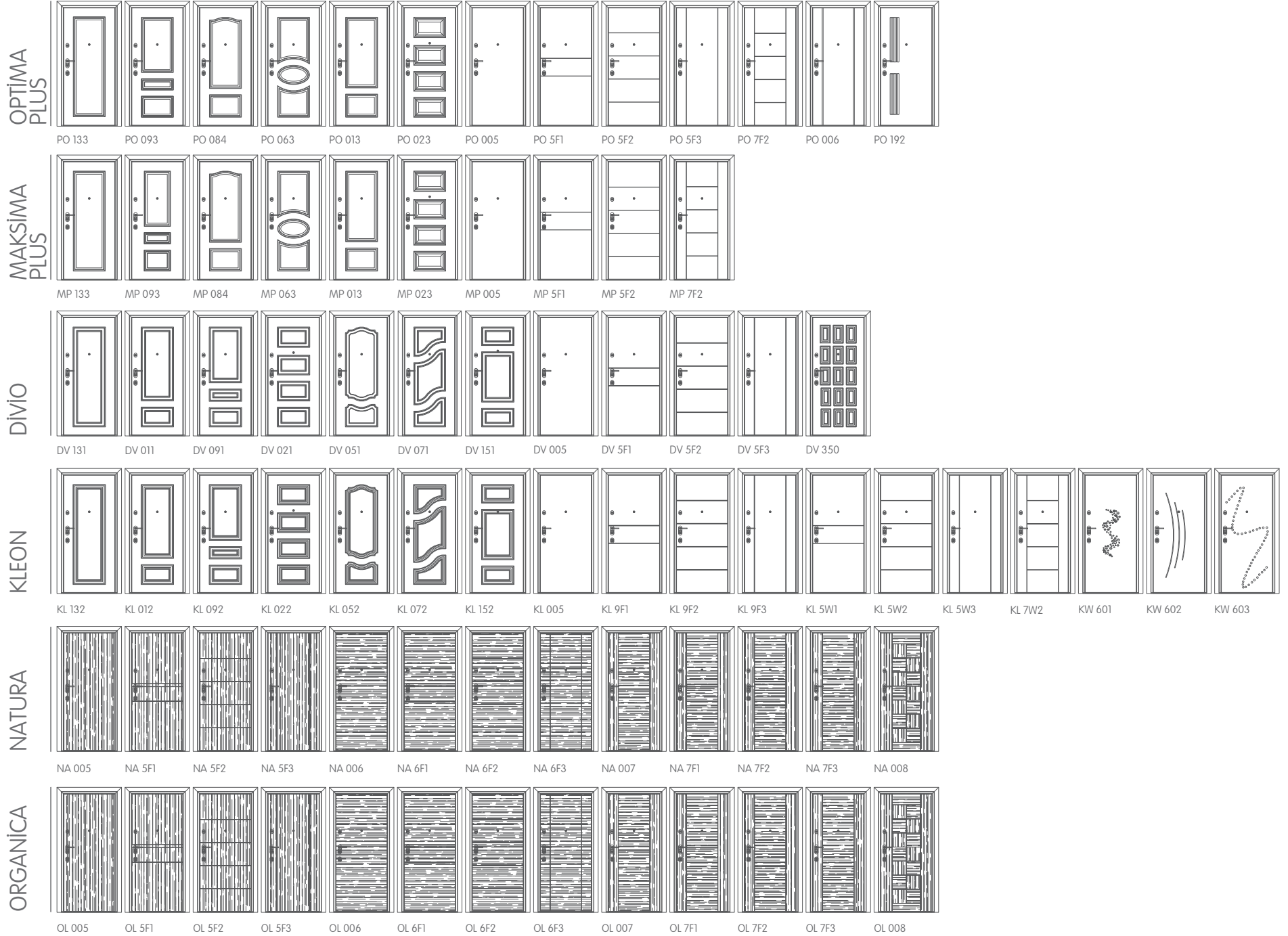

Standart özellikler Standard features

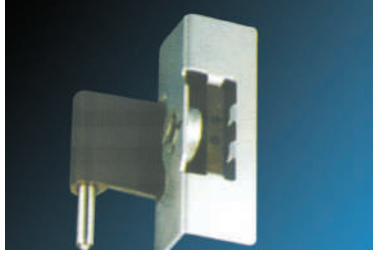

İsometrik Ayarlı Mikron Menteşe
Isometric Adjustable Micron Hinge

Uzun yıllar rahat ve güvenli kullanımı garanti eden, deprem esnasında yatay ve düşme milimetrik harekete izin veren isometrik ayarlı menteşe.

The isometric adjustable hinge guaranteeing comfortable and secure use for long years and allowing horizontal and vertical millimeter movement during earthquake.

Çelik gövde
Steel leaf

2 mm et kalınlığında omega çelik bloklarla takviyeli gövde. Hem dış kenarlardan hem de omega çelik desteklerinden yapılan özel kaynak sayesinde üstün dayanıklılık.

The body reinforced with omega steel blocks with 2 mm wall thickness. Outstanding durability with the special welding made from both outer edges and omega profile reinforcements.



Kapı Güvenlik Mandalı
Door Security Catch

Güvenlik nedeniyle veya istenmeyen durumlar için açılımı sınırlayan emniyet mandalı.

Safety catch limiting the opening due to security or undesirable situations.

Kör kasa / Kasa
Subframe / Frame

Galvanize çelikten imal edilmiş, darbe dayanımı yüksek 8 adet çelik ankraj ile duvara gömülen kör kasa ve özel kör kasası ile bire bir kenetlenen, hiçbir aletle esnetmeye yönelik müdahalelere izin vermeyen güvenlik kasası.

The subframe embedded to the wall with 8 steel anchorage with high shock resistance made from galvanized steel and the security frame exactly interlocking with the special blind frame and not allowing any intervention with any tool for bending.



Hareketli Giyotin Süpürgelik
Door Bottom Mobile Sill

Eşik ihtiyacını ortadan kaldıran, kapının kapanmasıyla otomatik olarak kapanan; hava, ses, toz ve suya karşı yalıtım sağlayan hareketli giyotin süpürgelik.

The door bottom mobile sill eliminating the need for threshold, automatically closing with the closure of the door and ensuring insulation against air, sound, dust and water.

İzolasyon
Insulation

Çelik gövde arasına monte edilen özel panellerle maksimum ses ve ısı yalıtımı.

Maximum sound and heat insulation with the panels installed between the steel frame.



Yüksek Güvenlik Bareli
High Security Profile Cylinder

Dışarıdan her türlü müdahaleyi önleyen manganez kaplı kilit bloğu ile güvenli kullanım sağlayan, pratik ve estetik kilit teknolojisi. Barelle birlikte gelen, üzerinde 10 adet teleskopikşifre ve 2 adet hareketli pim barındıran, kopyalanamayan anahtar.

Practical and esthetic lock technology offering secure use with manganese coated lock block preventing any kind of external intervention. The uncopyable key coming with the profile cylinder features 10 telescopic codes and 2 mobile pins.

1800 gözetleme dürbünü
180° spy hole

Maksimum görüş imkanı sağlayan, geniş açılı gözetleme dürbünü.

Wide-angle inspection hole allowing maximum visibility.



Güvenlik kartı
Security card

Anahtardan anahtar çoğaltma uygulamasına son veren yeni nesil güvenlik konsepti. Sadece kişiye özel güvenlik kartı ile yapılabilen anahtar çoğaltma teknolojisi

The new generation security concept bringing an end for duplicating keys from other keys. The key duplication technology only performed with personal security card. ibrazıyla.

Dekoratif ahşap giydirmeler
Decorative wooden panels

Lake, PVC, Endüstriyel ve Ahşap kaplamalı, darbe ve ısı dayanımı yüksek, lif ahşap paneller. Aynı kaplama ile kombine edilmiş kasa ve pervazlar.

Fiberboard wood panels with lacquer, PVC, engineered and wooden coating with high shock and heat resistance. Frames and architraves

Donanım Renk Seçenekleri Hardware Color Alternatives

Paslanmaz Çelik
Stainless Steel
 Parlak Krom
Chrome Polished
 Mat Krom
Chrome Matt
 Pirinç
Brass
 Bronz
Bronze

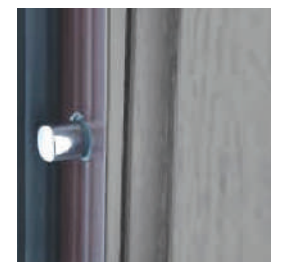

Sistem kesiti System section

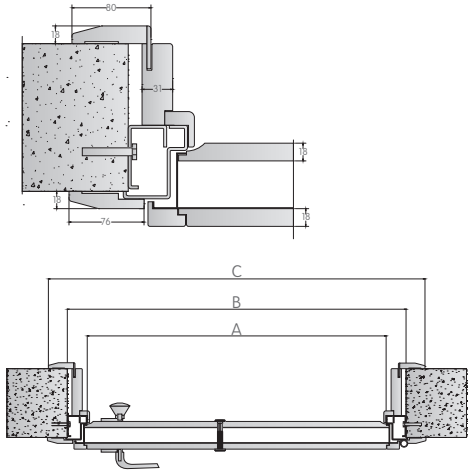

Pervaz Birleşim Seçenekleri Architrave Joints Options

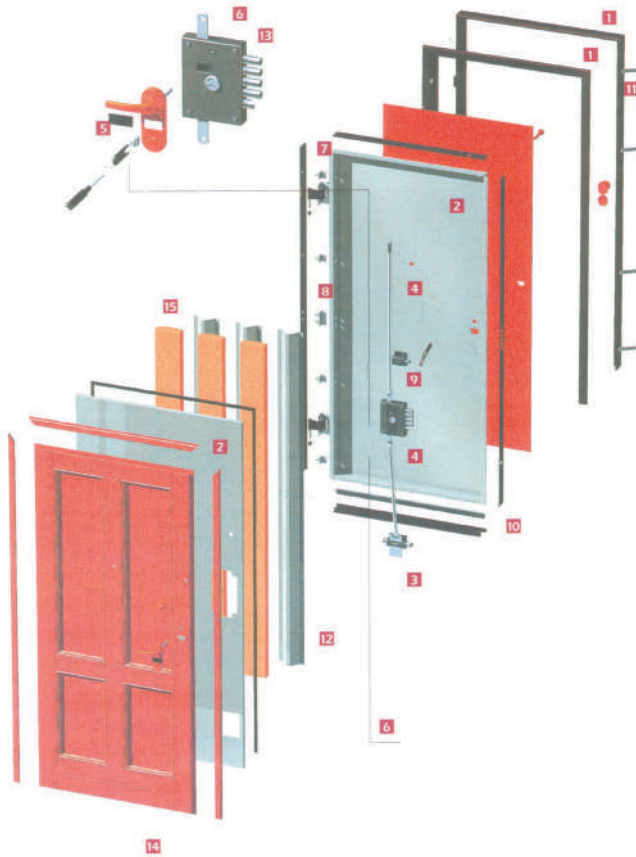

Standart ölçüler Standard dimensions

Genişlik / Width (mm)	A	B	C
Tek kanatlı kapı Single leaf door	850	970	1084
	900	1020	1134

Yükseklik / Height (mm)	E	F	G
Tek kanatlı kapı Single leaf door	2000	2060	2116
	2050	2110	2166
	2100	2160	2216

Duvar Kalınlığı / Wall thickness (mm)	D	D'	J
Tek kanatlı kapı Single leaf door	150	150-165	83
	165	165-180	98
	180	180-195	113
	195	195-210	128
	210	210-225	143
	225	225-240	158
	240	240-255	173
	255	255-270	188
	270	270-285	203

1. Deforme edilemeyen özel güvenlik kasa sistemi (iç kasa + kör kasa) / Non-deformable special security frame system (inner frame + subframe)
2. Galvanize çelik konstrüksiyon / Galvanized steel construction
3. Hareketli mil / Mobile shaft
4. Üst ve alt barel kontrol mili / Top and bottom profile cylinder control shaft
5. Yüksek güvenlik bareli / High security profile cylinder
6. Kilit bloğu / Lock block
7. Ayarlı mikron menteşeler / Adjustable micron hinges
8. Sökülmeye karşı sabit bareller / Fixed profile cylinders against dismantling
9. Kapı güvenlik mandalı / Door security catch
10. Hareketli giyotin süpürgelik / Door bottom mobile sill
11. Duvar içi ankrajları / In-wall anchorages
12. Güçlendirici omega profilleri / Reinforcing omega profiles
13. Delinemeyen manganez plaka / Impenetrable manganese plate
14. Lake, PVC, endüstriyel veya ahşap kaplamalı lif ahşap panel, kasa ve pervazlar / Fiber wooden panel, frame and architraves with lacquer, PVC, industrial or wooden coating
15. Isı ve ses yalıtımı için iç dolgu / Inner filling for heat and sound insulation

Sparta 9

Sparta 9 Dortek yüksek güvenlik bareline ek olarak ikinci bir barel opsiyonu sunarak güvenlik seviyesini arttırıyor.

Sparta 9 increases the safety level by offering a second barrel option in addition to Dortek high security cylinder.





Performans Uygulamaları Performance Applications



Kullanım Alanları Area of use

Otel / Hotel
Sparta 9 Daire Giriş Kapısı
Sparta 9 plus flat entrance door

Sparta 9 Çelik Kapı Giydirme Uygulaması
Sp 9 steel door wood panel applications

Çelik Kapı Giydirme Uygulaması
Steel door wood panel applications

* Düz ve Fugalı modellerde 6mm giydirme,
diğer tüm modellerde 14mm giydirme
uygulanacaktır.



SP9 MF 125
Masif Kayın / Beechwood

Uygulanabilir Seriler Available Series



Uygulanabilir Modeller
Styles

DIVIO



DV 131 DV 011 DV 091 DV 021 DV 051 DV 071 DV 151 DV 005 DV 5F1 DV 5F2 DV 5F3 DV 330 DV 340 DV 350 DV 355 DV 360 DV 370 DV 380

KLEON

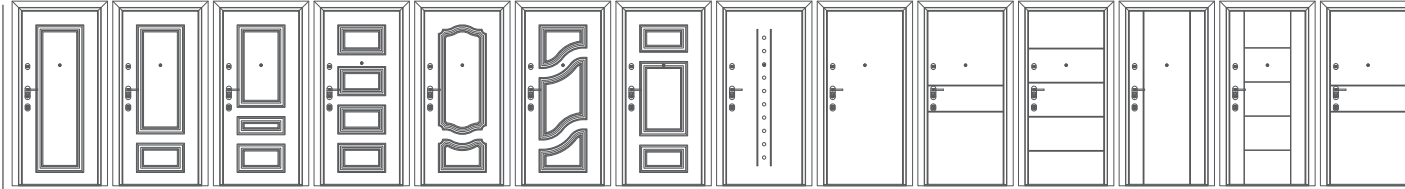

KL 132 KL 012 KL 092 KL 022 KL 052 KL 072 KL 152 KL 170 KL 005 KL 5F1 KL 5F2 KL 5F3 KL 7F2 KL 9F1



KL 9F2 KL 9F3 KL 5W1 KL 5W2 KL 5W3 KL 7W2 KW 601 KW 602 KW 603

NATURA

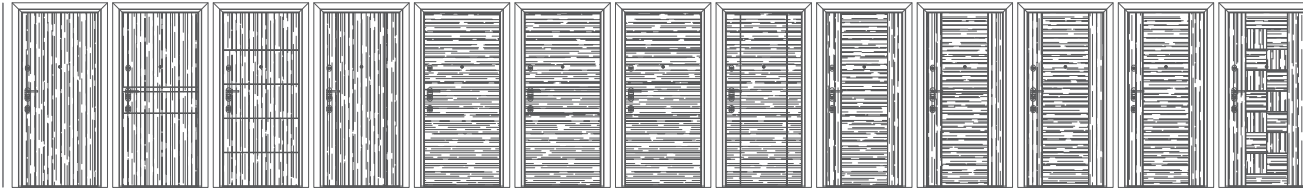

NA 005 NA 5F1 NA 5F2 NA 5F3 NA 006 NA 6F1 NA 6F2 NA 6F3 NA 007 NA 7F1 NA 7F2 NA 7F3 NA 008

ORGANICA

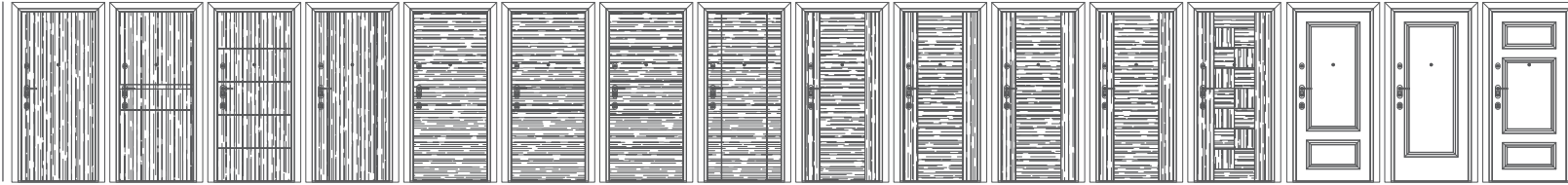

OL 005 OL 5F1 OL 5F2 OL 5F3 OL 006 OL 6F1 OL 6F2 OL 6F3 OL 007 OL 7F1 OL 7F2 OL 7F3 OL 008 OL 015 OL 135 OL 155

Standart özellikler Standard features

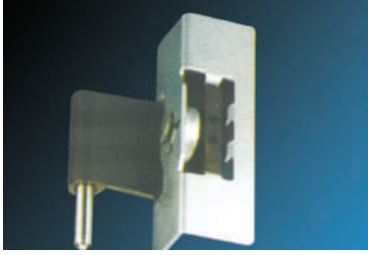

İsometrik Ayarlı Mikron Menteşe
Isometric Adjustable Micron Hinge

Uzun yıllar rahat ve güvenli kullanımı garanti eden, deprem esnasında yatay ve düşme milimetrik harekete izin veren isometrik ayarlı menteşe.

The isometric adjustable hinge guaranteeing comfortable and secure use for long years and allowing horizontal and vertical millimeter movement during earthquake.

Çelik gövde
Steel leaf

2 mm et kalınlığında omega çelik bloklarla takviyeli gövde. Hem dış kenarlardan hemde omega çelik desteklerinden yapılan özel kaynak sayesinde üstün dayanıklılık.

The body reinforced with omega steel blocks with 2 mm wall thickness. Outstanding durability with the special welding made from both outer edges and omega profile reinforcements.



Kapı Güvenlik Mandalı
Door Security Catch

Güvenlik nedeniyle veya istenmeyen durumlar için açılımı sınırlayan emniyet mandalı.

Safety catch limiting the opening due to security or undesirable situations.

Kör kasa / Kasa
Subframe / Frame

Galvanize çelikten imal edilmiş, darbe dayanımı yüksek 8 adet çelik ankraj ile duvara gömülen kör kasa ve özel kör kasası ile bire bir kenetlenen, hiçbir aletle esnetmeye yönelik müdahalelere izin vermeyen güvenlik kasası.

The subframe embedded to the wall with 8 steel anchorage with high shock resistance made from galvanized steel and the security frame exactly interlocking with the special blind frame and not allowing any intervention with any tool for bending.



Hareketli Giyotin Süpürgelik
Door Bottom Mobile Sill

Eşik ihtiyacını ortadan kaldıran, kapının kapanmasıyla otomatik olarak kapanan; hava, ses, toz ve suya karşı yalıtım sağlayan hareketli giyotin süpürgelik.

The door bottom mobile sill eliminating the need for threshold, automatically closing with the closure of the door and ensuring insulation against air, sound, dust and water.

İzolasyon
Insulation

Çelik gövde arasına monte edilen özel panellerle maksimum ses ve ısı yalıtımı.

Maximum sound and heat insulation with the panels installed between the steel frame.



Yüksek Güvenlik Bareli
High Security Profile Cylinder

Dışarıdan her türlü müdahaleyi önleyen manganez kaplı kilit bloğu ile güvenli kullanım sağlayan, pratik ve estetik kilit teknolojisi. Barelle birlikte gelen, üzerinde 10 adet teleskopik şifre ve 2 adet hareketli pim barındıran, kopyalanamayan anahtar.

Practical and esthetic lock technology offering secure use with manganese coated lock block preventing any kind of external intervention. The uncopyable key coming with the profile cylinder features 10 telescopic codes and 2 mobile pins.

180° gözetleme dürbünü
180° spy hole

Maksimum görüş imkanı sağlayan, geniş açılı gözetleme dürbünü.

Wide-angle inspection hole allowing maximum visibility.



Güvenlik kartı
Security card

Anahtardan anahtar çoğaltma uygulamasına son veren yeni nesil güvenlik konsepti. Sadece kişiye özel güvenlik kartı ile yapılabilen anahtar çoğaltma teknolojisi

The new generation security concept bringing an end for duplicating keys from other keys. The key duplication technology only performed with personal security card. ibrazyıla.

Dekoratif ahşap giydirmeler
Decorative wooden panels

Lake, PVC, Endüstriyel ve Ahşap kaplamalı, darbe ve ısı dayanımı yüksek, lif ahşap paneller. Aynı kaplama ile kombine edilmiş kasa ve pervazlar.

Fiberboard wood panels with lacquer, PVC, engineered and wooden coating with high shock and heat resistance. Frames and architraves

Donanım Renk Seçenekleri Hardware Color Alternatives



Sistem kesiti System section

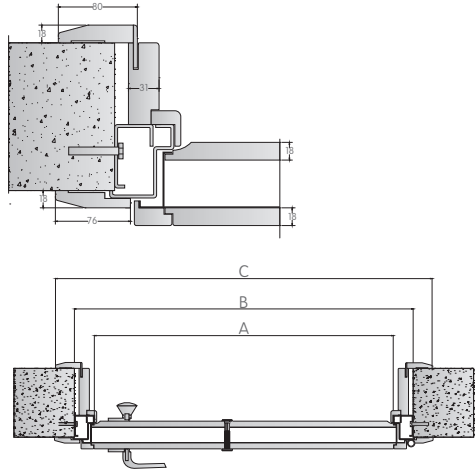

Pervaz Birleşim Seçenekleri Architrave Joints Options

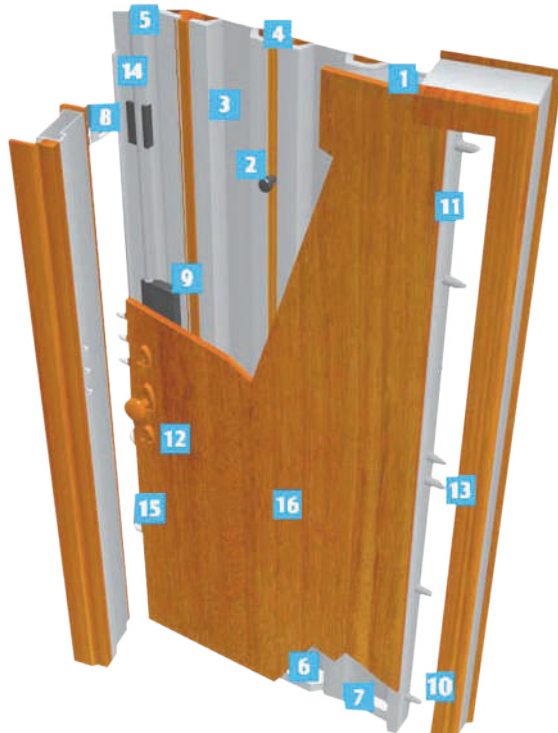

Standart ölçüler Standard dimensions

Genişlik / Width (mm) A B C

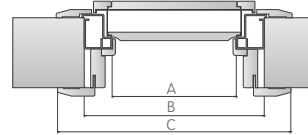

Tek kanatlı kapı
Single leaf door



850	970	1084
900	1020	1134

Yükseklik / Height (mm) E F G

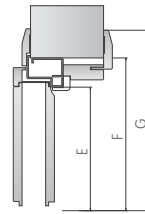

Tek kanatlı kapı
Single leaf door



2000	2060	2116
2050	2110	2166

Duvar Kalınlığı / Wall thickness (mm) D D' J

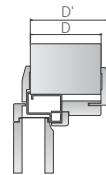

Tek kanatlı kapı
Single leaf door



150	150-165	83
165	165-180	98
180	180-195	113
195	195-210	128
210	210-225	143
225	225-240	158
240	240-255	173
255	255-270	188
270	270-285	203

1. Deforme edilemeyen özel güvenlik kasa sistemi (iç kasa + kör kasa) / Non-deformable special security frame system (inner frame + subframe)
2. 180° gözetleme dürbünü / 180° spy hole
3. Güçlendirici omega profilleri / Reinforcing omega profiles
4. Isı ve ses izolasyonu için iç dolgu / Inner filling for heat and sound insulation
5. Üst ve alt barel kontrol mili / Top and bottom profile cylinder control shaft
6. Galvanize çelik konstrüksiyon / Galvanized steel construction
7. Hareketli giyotin süpürgelik / Door bottom mobile sill
8. Kapı güvenlik mandalı / Door security catch
9. Manganez kaplı kilit bloğu / Manganese coated lock block
10. Isı ve ses yalıtım fitilleri / Heat and sound insulation beads
11. Kenar profili / Side profile
12. Hizmetli kilidi / Service lock
13. Sökülmeye karşı sabit bareller / Profile cylinders against dismantling
14. Üst barel ve deviyatör kumanda mili / Top profile cylinder and deviator command shaft
15. Kancalı mil / Hook shaft
16. Lake, PVC, endüstriyel veya ahşap kaplamalı lif ahşap panel, kasa ve pervazlar / Fiber wooden panel, frame and architraves with lacquer, PVC, industrial or wooden coating

Wall Security

Wall Security teknoloji ve güvenliđi aynı potada eritirken, eşsiz bir tasarım sunuyor.

Wall Security serves an unique design while it harmonies the texchnology and security.





Performans Uygulamaları Performance Applications



Kullanım Alanları Area of use

Otel / Hotel
Wall Security Giriş Kapısı
Wall Security flat entrance door

Wall Security Çelik Kapı Giydirme Uygulaması
Wall Security steel door wood panel applications

Çelik Kapı Giydirme Uygulaması
Steel door wood panel applications



Wall Security
Mavi / Blue

Öneriler Suggestions

*Wall Security serisi kapıların, dış hava koşullarına direkt olarak maruz kalınan noktalarda kullanılması kesinlikle önerilmemektedir. Sundurma, rüzgarlık, gölgelik ve benzeri yarı korumalı sistemlerden sonra ABS panel yüzey kaplaması giriş kapısı olarak kullanılabilir.

It is not recommended to use Wall Security series doors in places exposed directly to weather condition. Can only be used, if door location is protected from weather conditions by porch, shade etc.

! Performans uygulamalarında ve bazı açılım seçeneklerinde kanat kalınlığı değişmektedir.

Leaf width may differ in some performance door applications and door opening.

Renk Seçenekleri
Color Alternatives



Mavi
Blue



Turuncu
Orange



Gri
Gray



Beyaz
White



Wall Security

Standart özellikler Standard features



Gizli menteşe
Concealed hinge

Uzun yıllar rahat ve güvenli kullanımı garanti eden, kanadın 1800 açılımına izin veren tamamen gizlenmiş, estetik, dekoratif menteşe.

Fully concealed hinges allowing 180° expansion of the leaf and guaranteeing comfortable and secure use for long years.

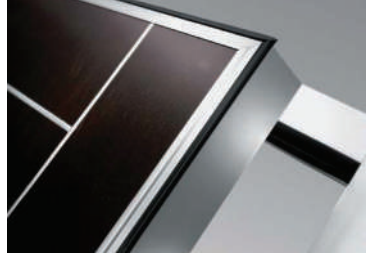

Alüminyum kenar profili
Aluminum edge profile

Pürüzsüz kanat, kenar yüzeyi ve birleşim noktalarında zarif alüminyum kenar profili.

Elegant aluminum side profile on smooth leaf, edge surface and joints.

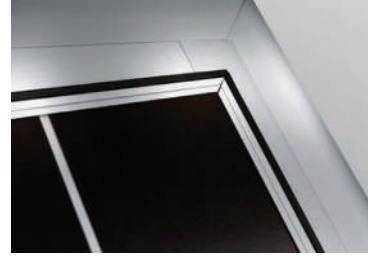

Alüminyum kasa profili
Aluminum frame profile

Kanat yüzeyi ile uyumlu, zarif kenar çizgisinin devamı, gümüş eloksal işleme sonlandırılmış alüminyum kasa profili.

Aluminum frame profile, compatible with the leaf surface and the continuance of the elegant side line is finished with silver eloxal treatment.



Sabit Mil
Fixed Shaft

Kasa ve kanadın mükemmel birleşimini garanti eden, dışarıdan müdahalelerde sistemi kilitleyen sabit mil.

The fixed shaft guaranteeing the perfect combination of the frame and leaf and locking the system in case of any external intervention.



Mia Kilit Sistemi
Mia Lock System

Rahat kullanım sağlayan, bir sustalı ve iki klasik anahtarla gelen, kullanımı dünyaca yaygın Mia tipi kilit seçeneği. İçeriden kolayca değiştirilebilen patentli kilit teknolojisi.

Globally used Mia type lock option ensuring convenient use and coming with one safety catch and two classical keys. The patented lock technology which can be easily replaced inside.

Donanım Renk Seçenekleri Hardware Color Alternatives



Bir güvenlik kapısının sağladığı güven, gizli menteşelerin zarifliği, 180° açılım ve tüm güvenlik kapama sistemlerine uyumluluk.

The reliability of a security door, the elegance of hidden hinges, the 180° wide opening and adaptability to all security closure systems.



Standart ölçüler Standard dimensions

Genişlik / Width (mm)

A B C

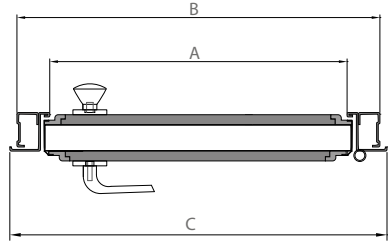

Tek kanatlı kapı
Single leaf door

900	1020	1056
850	970	1006
800	920	956

Yükseklik / Height (mm)

E F G

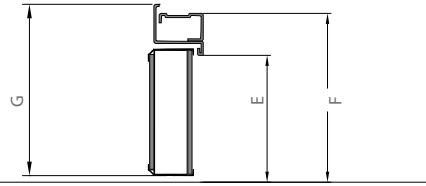

Tek kanatlı kapı
Single leaf door

2100	2160	2178
2200	2260	2278

Sistem Kesiti System Section

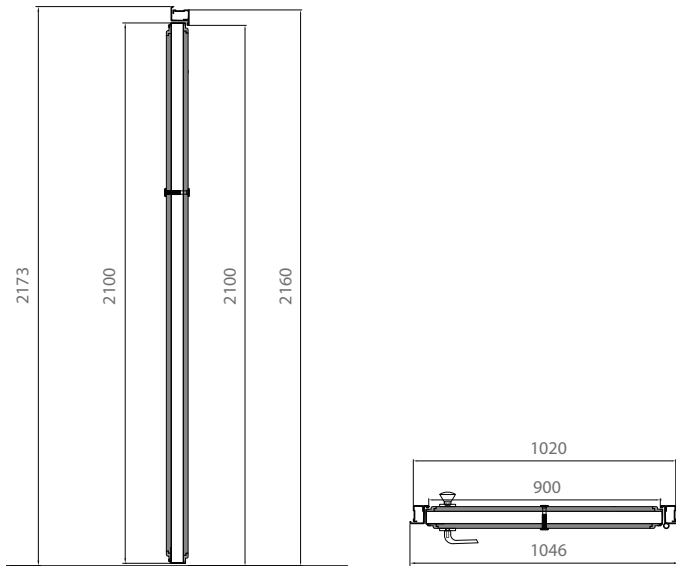

Modelli üretim kesit

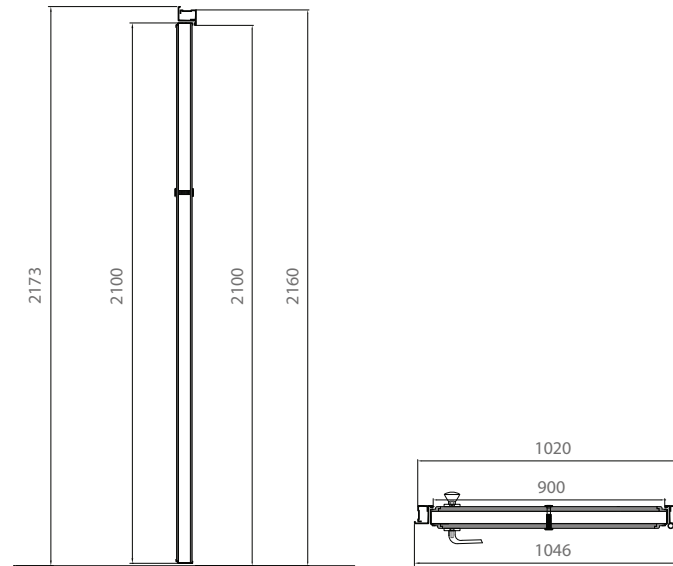

ABS panel üretim kesit

Bütünleşik Ahşap Çözümleri / Integrated Wood Solutions

Otel Proje Çözümleri
Hotel Project Solutions

Otel Proje Çözümleri

Hotel project solutions

Performans Uygulamaları Performance Applications

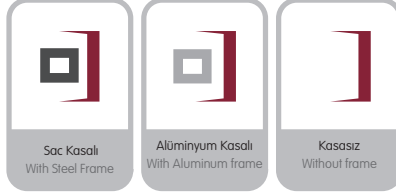

Kullanım Alanları Area of use

Ofis / Office
Konut / Residence

Öneriler Suggestions

*Otel oda giriş kapısı olarak üretilen kapılardaki kanat kalınlığı, donanım seçenekleri ve pervaz detayları, ilgili ürün gruplarındaki standartlar ile aynıdır. Kasa detayı farklıdır, 45mm kalınlığındadır. Otel tipi özel kartlı kilit ile sunulur. Proje gereksinimlerine göre farklı aksesuar seçenekleri değerlendirilebilmektedir.

The leaf thickness, equipment options and architrave details of the doors manufactured as hotel room entrance door are the same with the standards of other product groups. Only the frame detail is different and it has a thickness of 45 mm. The hotel type door is provided with special card lock. It can be evaluated with different accessory options according to the project requirements.



Uygulanabilir Seriler Available Series

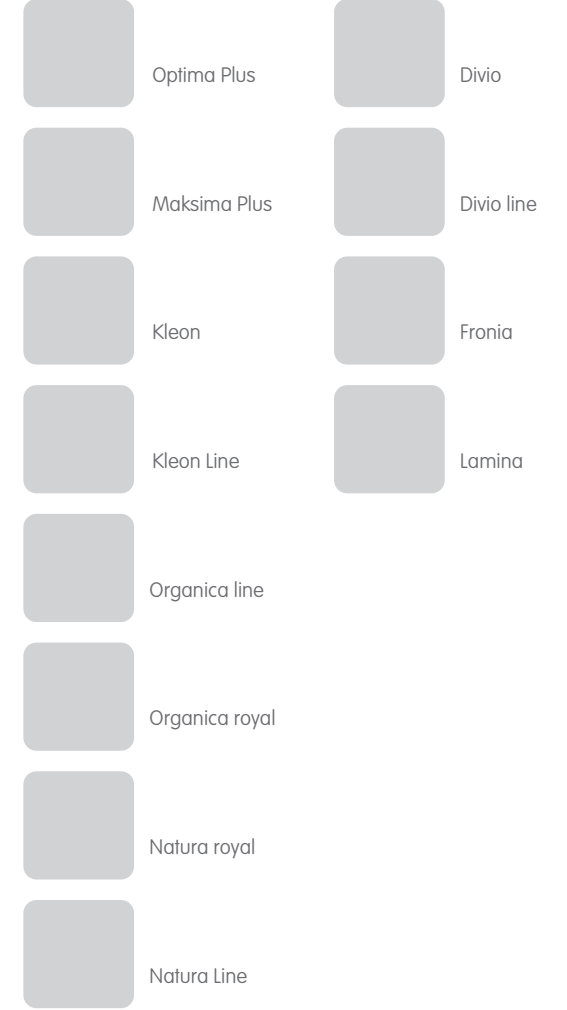

İlgili ürün gruplarındaki tüm dolu kapılar (camsız modeller) otel oda giriş kapısı olarak üretilmektedir.

All standart interior door styles (except glazed door styles) can be produced as hotel room entrance door.

Standart Donanım Standard Hardware



Hidrolik kapatıcı
Door closer

Opsiyonel Donanım Optional Hardware



Kilit seçenekleri
Lock options



Duvar terminali
Wall terminal



Enerji tasarruf cihazı
Energy saver



Dürbün
Door viewer



Giyotin süpürgelik
Panic bar

Kasa - Pervaz seçenekleri Frame - Architrave options

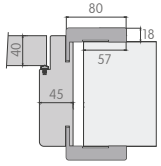

P 005 OTEL KASA
STANDART

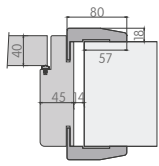

P 208 OTEL KASA
OPSİYONEL

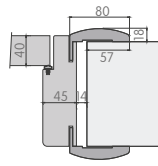

P 108 OTEL KASA
OPSİYONEL

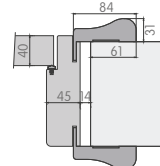

P 608 OTEL KASA
OPSİYONEL



SELECTRON INVEST SRL

Calea Baciului, nr. 1-3,
Cluj-Napoca, România

T: +40 737 06 70 70

contact@horecapapatya.ro

www.horecapapatya.ro